



This Computer program (including software design, programming structure, graphics, manual, and on-line help) was created by the pcaStructurePoint, the Engineering Software Group of the Portland Cement Association.

Winsoft Software Inc. of Ottawa, Ontario, Canada, assisted in the development of the graphical interface.

While the Portland Cement Association has taken every precaution to utilize the existing state-of-the-art and to assure the correctness of the analytical solution techniques used in this program, the responsibilities for modeling the structure, inputting data, applying engineering judgment to evaluate the output, and implementing engineering drawings remain with the structural engineer of record. Accordingly, Portland Cement Association does and must disclaim any and all responsibility for defects or failures of structures in connection with which this program is used.

© 1988 – 2004 Portland Cement Association. All Rights Reserved.

pcaWall is a Trademark of the Portland Cement Association

Microsoft and Windows are registered trademarks of the Microsoft Corporation.

License Agreements

PORTLAND CEMENT ASSOCIATION EVALUATION SOFTWARE LICENSE AGREEMENT

BY CLICKING THE "I AGREE" ICON BELOW, OR BY INSTALLING, COPYING, OR OTHERWISE USING THE SOFTWARE OR USER DOCUMENTATION, YOU AGREE TO BE BOUND BY THE TERMS OF THIS AGREEMENT, INCLUDING, BUT NOT LIMITED TO, THE WARRANTY DISCLAIMERS, LIMITATIONS OF LIABILITY AND TERMINATION PROVISIONS BELOW. IF YOU DO NOT AGREE TO THE TERMS OF THIS AGREEMENT, DO NOT INSTALL OR USE THE SOFTWARE OR USER DOCUMENTATION, EXIT THIS APPLICATION NOW AND RETURN THE SOFTWARE AND USER DOCUMENTATION TO PCA.

PORTLAND CEMENT ASSOCIATION, 5420 OLD ORCHARD ROAD, SKOKIE, ILLINOIS 60077 (HEREAFTER PCA), GRANTS THE CUSTOMER A PERSONAL, NONEXCLUSIVE, LIMITED, NONTRANSFERABLE LICENSE TO USE THIS SOFTWARE AND USER DOCUMENTATION SOLELY FOR TRIAL AND EVALUATION PURPOSES ONLY IN ACCORDANCE WITH THE TERMS AND CONDITIONS OF THIS AGREEMENT. SOFTWARE AND USER DOCUMENTATION IS SUPPLIED TO CUSTOMER EITHER BY PCA DIRECTLY OR THROUGH AN AUTHORIZED DEALER OF PCA (HEREAFTER DEALER).

WHILE PCA HAS TAKEN PRECAUTIONS TO ASSURE THE CORRECTNESS OF THE ANALYTICAL SOLUTION AND DESIGN TECHNIQUES USED IN THIS SOFTWARE, IT CANNOT AND DOES NOT GUARANTEE ITS PERFORMANCE, NOR CAN IT OR DOES IT BEAR ANY RESPONSIBILITY FOR DEFECTS OR FAILURES IN STRUCTURES IN CONNECTION WITH WHICH THIS SOFTWARE MAY BE USED. DEALER (IF ANY) HAS NOT PARTICIPATED IN THE DESIGN OR DEVELOPMENT OF THIS SOFTWARE AND NEITHER GUARANTEES THE PERFORMANCE OF THE SOFTWARE NOR BEARS ANY RESPONSIBILITY FOR DEFECTS OR FAILURES IN STRUCTURES IN CONNECTION WITH WHICH THIS SOFTWARE IS USED.

PCA AND DEALER (IF ANY) EXPRESSLY DISCLAIM ANY WARRANTY THAT: (A) THE FUNCTIONS CONTAINED IN THE SOFTWARE WILL MEET THE REQUIREMENTS OF CUSTOMER OR OPERATE IN COMBINATIONS THAT MAY BE SELECTED FOR USE BY CUSTOMER; (B) THE OPERATION OF THE SOFTWARE WILL BE FREE OF ALL "BUGS" OR PROGRAM ERRORS; OR (C) THE SOFTWARE CONFORMS TO ANY PERFORMANCE SPECIFICATIONS. CUSTOMER ACKNOWLEDGES THAT PCA IS UNDER NO OBLIGATION TO PROVIDE ANY SUPPORT, UPDATES, BUG FIXES OR ERROR CORRECTIONS TO OR FOR THE SOFTWARE OR USER DOCUMENTATION.

THE LIMITED WARRANTIES IN SECTION 6 HEREOF ARE IN LIEU OF ALL OTHER WARRANTIES, EXPRESS OR IMPLIED, INCLUDING, BUT NOT LIMITED TO, ANY IMPLIED WARRANTIES OF NON-INFRINGEMENT, MERCHANTABILITY OR FIT NESS FOR A PARTICULAR PURPOSE, EACH OF WHICH IS HEREBY DISCLAIMED. EXCEPT AS SET FORTH IN SECTION 6, THE SOFTWARE AND USER DOCUMENTATION ARE PROVIDED ON AN "AS-IS" BASIS.

IN NO EVENT SHALL PCA OR DEALER (IF ANY) BE LIABLE FOR: (A) LOSS OF PROFITS, DIRECT, INDIRECT, INCIDENTAL, SPECIAL, EXEMPLARY, PUNITIVE, CONSEQUENTIAL OR OTHER DAMAGES, EVEN IF PCA OR DEALER (IF ANY) HAS BEEN ADVISED OF THE POSSIBILITY OF SUCH DAMAGES; (B) ANY CLAIM AGAINST CUSTOMER BY ANY THIRD

PARTY; OR (C) ANY DAMAGES CAUSED BY (1) DELAY IN DELIVERY OF THE SOFTWARE OR USER DOCUMENTATION UNDER THIS AGREEMENT; (2) THE PERFORMANCE OR NON PERFORMANCE OF THE SOFTWARE; (3) RESULTS FROM USE OF THE SOFTWARE OR USER DOCUMENTATION, INCLUDING, WITHOUT LIMITATION, MISTAKES, ERRORS, INACCURACIES, FAILURES OR CUSTOMER'S INABILITY TO PROVIDE SERVICES TO THIRD PARTIES THROUGH USE OF THE SOFTWARE OR USER DOCUMENTATION; (4) CUSTOMER'S FAILURE TO PERFORM CUSTOMER'S RESPONSIBILITIES; (5) PCA NOT PROVIDING UPDATES, BUG FIXES OR CORRECTIONS TO OR FOR ANY OF THE SOFTWARE OR USER DOCUMENTATION; (6) LABOR, EXPENSE OR MATERIALS NECESSARY TO REPAIR DAMAGE TO THE SOFTWARE OR USER DOCUMENTATION CAUSED BY (a) ACCIDENT, (b) NEGLIGENCE OR ABUSE BY CUSTOMER, (c) ACTS OF THIRD PERSONS INCLUDING, BUT NOT LIMITED TO, INSTALLATION, REPAIR, MAINTENANCE OR OTHER CORRECTIVE WORK RELATED TO ANY EQUIPMENT BEING USED, (d) CAUSES EXTERNAL TO THE SOFTWARE SUCH AS POWER FLUCTUATION AND FAILURES, OR (e) FLOODS, WINDSTORMS OR OTHER ACTS OF GOD. MOREOVER, IN NO EVENT SHALL PCA BE LIABLE FOR WARRANTIES, GUARANTEES, REPRESENTATIONS OR ANY OTHER UNDERSTANDINGS BETWEEN CUSTOMER AND DEALER (IF ANY) RELATING TO THE SOFTWARE OR USER DOCUMENTATION.

THIS AGREEMENT CONSTITUTES THE ENTIRE AND EXCLUSIVE AGREEMENT BETWEEN CUSTOMER AND PCA AND DEALER (IF ANY) WITH RESPECT TO THE SOFTWARE AND USER DOCUMENTATION TO BE FURNISHED HEREUNDER. IT IS A FINAL EXPRESSION OF THAT AGREEMENT AND UNDERSTANDING. IT SUPERSEDES ALL PRIOR COMMUNICATIONS BETWEEN THE PARTIES (INCLUDING ANY EVALUATION LICENSE AND ALL ORAL AND WRITTEN PROPOSALS). ORAL STATEMENTS MADE BY PCA'S OR DEALER'S (IF ANY) REPRESENTATIVES ABOUT THE SOFTWARE OR USER DOCUMENTATION DO NOT CONSTITUTE REPRESENTATIONS OR WARRANTIES, SHALL NOT BE RELIED ON BY CUSTOMER, AND ARE NOT PART OF THIS AGREEMENT.

1. LICENSE RESTRICTIONS

- (a) Except as expressly provided in this Agreement or as otherwise authorized in writing by PCA, Customer has no right to: (1) use, print, copy, display, reverse assemble, reverse engineer, translate or decompile the Software or User Documentation in whole or in part; (2) disclose, publish, release, sublicense or transfer to another person any Software or User Documentation; (3) reproduce the Software or User Documentation for the use or benefit of anyone other than Customer; or (4) modify any Software or User Documentation. All rights to the Software and User Documentation not expressly granted to Customer hereunder are retained by PCA. All copyrights and other proprietary rights except as expressed elsewhere in the Software or User Documentation and legal title thereto shall remain in PCA. Customer may use the Software at only one designated workstation at Customer's site at any given time. Customer may not transmit the Software electronically to any other workstation, computer, node or terminal device whether via a local area network, a wide area network, telecommunications transmission, the Internet or other means now known or hereafter created without prior written permission by PCA.
- (b) Customer acknowledges that this is a limited license for trial and evaluation purposes only. This limited license shall automatically terminate upon the earlier of: (1) ten executions of the Software on the computer on which it is installed; or (2) fifteen days after the installation of the Software. Thereafter, Customer may only use the Software and Documentation if it acquires a production license for the same.

2. TERM AND TERMINATION

- (a) This Agreement shall be in effect from the date Customer clicks the "I AGREE" icon below or installs, copies or otherwise uses the Software or User Documentation until: (1) it is terminated by Customer, by Dealer (if any) on behalf of Customer or PCA or by PCA as set forth herein; or (2) the limited trial and evaluation license terminates.
- (b) This Agreement may be terminated by PCA without cause upon 30 days' written notice or immediately upon notice to Customer if Customer breaches this Agreement or fails to comply with any of its terms or conditions. This Agreement may be terminated by Customer without cause at any time upon written notice to PCA.

3. BACKUP AND REPLACEMENT COPIES

Customer may make one copy of the Software for back-up and archival purposes only, provided PCA's copyright and other proprietary rights notices are included on such copy.

4. PROTECTION AND SECURITY

- (a) Customer shall not provide or otherwise make available any of the Software or User Documentation in any form to any person other than employees of Customer with the need to know, without PCA's written permission.
- (b) All Software and User Documentation in Customer's possession including, without limitation, translations, compilations, back-up, and partial copies is the property of PCA. Upon termination of this Agreement for any reason, Customer shall immediately destroy all Software and User Documentation, including all media, and destroy any Software that has been copied onto other magnetic storage devices. Upon PCA's request, Customer shall certify its compliance in writing with the foregoing to PCA.
- (c) Customer shall take appropriate action, by instruction, agreement or otherwise, with any persons permitted access to the Software or User Documentation, to enable Customer to satisfy its obligations under this Agreement with respect to use, copying, protection, and security of the same.
- (d) If PCA prevails in an action against Customer for breach of the provisions of this Section 4, Customer shall pay the reasonable attorneys' fees, costs, and expenses incurred by PCA in connection with such action in addition to any award of damages.

5. CUSTOMER'S RESPONSIBILITIES

The essential purpose of this Agreement is to provide Customer with limited use rights to the Software and User Documentation. Customer accepts full responsibility for: (a) selection of the Software and User Documentation to satisfy Customer's business needs and achieve Customer's intended results; (b) the use, set-up and installation of the Software and User Documentation; (c) all results obtained from use of the Software and User Documentation; and (d) the selection, use of, and results obtained from any other software, programming equipment or services used with the Software or User Documentation.

6. LIMITED WARRANTIES

PCA and Dealer (if any) warrants to Customer that: (a) PCA and Dealer (if any) has title to the Software and User Documentation and/or the right to grant Customer the rights granted

hereunder; (b) the Software and User Documentation provided hereunder is PCA's most current production version thereof; and (c) the copy of the Software provided hereunder is an accurate reproduction of the original from which it was made.

7. LIMITATION OF REMEDY

- (a) **PCA AND DEALER (IF ANY) HAS NO LIABILITY UNDER THIS AGREEMENT. CUSTOMER'S EXCLUSIVE REMEDY FOR DAMAGES DUE TO PERFORMANCE OR NONPERFORMANCE OF ANY SOFTWARE OR USER DOCUMENTATION, PCA, DEALER (IF ANY), OR ANY OTHER CAUSE WHATSOEVER, AND REGARDLESS OF THE FORM OF ACTION, WHETHER IN CONTRACT OR IN TORT, INCLUDING NEGLIGENCE, SHALL BE LIMITED TO CUSTOMER STOPPING ALL USE OF THE SOFTWARE AND USER DOCUMENTATION AND RETURNING THE SAME TO PCA.**

- (b) **NEITHER PCA NOR DEALER (IF ANY) IS AN INSURER WITH REGARD TO THE PERFORMANCE OF THE SOFTWARE OR USER DOCUMENTATION. THE TERMS OF THIS AGREEMENT, INCLUDING, BUT NOT LIMITED TO, THE LIMITED WARRANTIES, AND THE LIMITATION OF LIABILITY AND REMEDY, ARE A REFLECTION OF THE RISKS ASSUMED BY THE PARTIES. IN ORDER TO OBTAIN THE SOFTWARE AND USER DOCUMENTATION FROM PCA OR DEALER (IF ANY), CUSTOMER HEREBY ASSUMES THE RISKS FOR (1) ALL LIABILITIES DISCLAIMED BY PCA AND DEALER (IF ANY) ON THE FACE HEREOF; AND (2) ALL ACTUAL OR ALLEGED DAMAGES IN CONNECTION WITH THE USE OF THE SOFTWARE AND USER DOCUMENTATION. THE ESSENTIAL PURPOSE OF THE LIMITED REMEDY PROVIDED CUSTOMER HEREUNDER IS TO ALLOCATE THE RISKS AS PROVIDED ABOVE.**

8. U.S. GOVERNMENT RESTRICTED RIGHTS

This commercial computer software and commercial computer software documentation were developed exclusively at private expense by Portland Cement Association, 5420 Old Orchard Road, Skokie, Illinois, 60077. U.S. Government rights to use, modify, release, reproduce, perform, display or disclose this computer software and computer software documentation are subject to the restrictions of DFARS 227.7202-1(a) (June 1995) and DFARS 227.7202-3(a) (June 1995), or the Restricted Rights provisions of FAR 52.227-14 (June 1987) and FAR 52.227-19 (June 1987), as applicable.

9. GENERAL

- (a) No action arising out of any claimed breach of this Agreement or transactions under this Agreement may be brought by Customer more than two years after the cause of such action has arisen.

- (b) Customer may not assign, sell, sublicense or otherwise transfer this Agreement, the license granted herein or the Software or User Documentation by operation of law or otherwise without the prior written consent of PCA. Any attempt to do any of the foregoing without PCA's consent is void.

- (c) Customer acknowledges that the Software, User Documentation and other proprietary information and materials of PCA are unique and that, if Customer breaches this Agreement, PCA may not have an adequate remedy at law and PCA may enforce its rights hereunder by an action for

damages and/or injunctive or other equitable relief without the necessity of proving actual damage or posting a bond therefor.

- (D) THE RIGHTS AND OBLIGATIONS UNDER THIS AGREEMENT SHALL NOT BE GOVERNED BY THE UNITED NATIONS CONVENTION ON CONTRACTS FOR THE INTERNATIONAL SALE OF GOODS, THE APPLICATION OF WHICH IS EXPRESSLY EXCLUDED, BUT SUCH RIGHTS AND OBLIGATIONS SHALL INSTEAD BE GOVERNED BY THE LAWS OF THE STATE OF ILLINOIS, APPLICABLE TO CONTRACTS ENTERED INTO AND PERFORMED ENTIRELY WITHIN THE STATE OF ILLINOIS AND APPLICABLE FEDERAL (U.S.) LAWS. UCITA SHALL NOT APPLY TO THIS AGREEMENT.
- (E) THIS AGREEMENT SHALL BE TREATED AS THOUGH IT WERE EXECUTED IN THE COUNTY OF COOK, STATE OF ILLINOIS, AND WAS TO HAVE BEEN PERFORMED IN THE COUNTY OF COOK, STATE OF ILLINOIS. ANY ACTION RELATING TO THIS AGREEMENT SHALL BE INSTITUTED AND PROSECUTED IN A COURT LOCATED IN COOK COUNTY, ILLINOIS. CUSTOMER SPECIFICALLY CONSENTS TO EXTRATERRITORIAL SERVICE OF PROCESS.
- (f) Except as prohibited elsewhere in this Agreement, this Agreement shall be binding upon and inure to the benefit of the personal and legal representatives, permitted successors, and permitted assigns of the parties hereto.
- (g) All notices, demands, consents or requests that may be or are required to be given by any party to another party shall be in writing. All notices, demands, consents or requests given by the parties hereto shall be sent either by U.S. certified mail, postage prepaid or by an overnight international delivery service, addressed to the respective parties. Notices, demands, consents or requests served as set forth herein shall be deemed sufficiently served or given at the time of receipt thereof.
- (h) The various rights, options, elections, powers, and remedies of a party or parties to this Agreement shall be construed as cumulative and no one of them exclusive of any others or of any other legal or equitable remedy that said party or parties might otherwise have in the event of breach or default in the terms hereof. The exercise of one right or remedy by a party or parties shall not in any way impair its rights to any other right or remedy until all obligations imposed on a party or parties have been fully performed.
- (i) No waiver by Customer, PCA or Dealer (if any) of any breach, provision, or default by the other shall be deemed a waiver of any other breach, provision or default.
- (j) The parties hereto, and each of them, agree that the terms of this Agreement shall be given a neutral interpretation and any ambiguity or uncertainty herein should not be construed against any party hereto.
- (k) If any provision of this Agreement or portion thereof is held to be unenforceable or invalid by any court or competent jurisdiction, such decision shall not have the effect of invalidating or voiding the remainder of this Agreement, it being the intent and agreement of the parties that this Agreement shall be deemed amended by modifying such provision to the extent necessary to render it enforceable and valid while preserving its intent or, if such modification is not possible, by substituting therefor another provision that is enforceable and valid so as to materially effectuate the parties' intent.
- (l) Except as set forth herein, this Agreement may be modified or amended only by a written instrument signed by a duly authorized representative of PCA and Customer.

PORTLAND CEMENT ASSOCIATION SOFTWARE LICENSE AGREEMENT

BY CLICKING THE "I AGREE" BELOW, OR BY INSTALLING, COPYING, OR OTHERWISE USING THE SOFTWARE OR USER DOCUMENTATION, YOU AGREE TO BE BOUND BY THE TERMS OF THIS AGREEMENT, INCLUDING, BUT NOT LIMITED TO, THE WARRANTY DISCLAIMERS, LIMITATIONS OF LIABILITY AND TERMINATION PROVISIONS BELOW. IF YOU DO NOT AGREE TO THE TERMS OF THIS AGREEMENT, DO NOT INSTALL OR USE THE SOFTWARE OR USER DOCUMENTATION, EXIT THIS APPLICATION NOW AND RETURN THE SOFTWARE AND USER DOCUMENTATION TO PCA FOR A FULL REFUND WITHIN THIRTY DAYS AFTER YOUR RECEIPT OF THE SOFTWARE AND USER DOCUMENTATION.

PORTLAND CEMENT ASSOCIATION, 5420 OLD ORCHARD ROAD, SKOKIE, ILLINOIS 60077 (HEREAFTER PCA), GRANTS THE CUSTOMER A PERSONAL, NONEXCLUSIVE, LIMITED, NONTRANSFERABLE LICENSE TO USE THIS SOFTWARE AND USER DOCUMENTATION IN ACCORDANCE WITH THE TERMS AND CONDITIONS OF THIS AGREEMENT. SOFTWARE AND USER DOCUMENTATION IS SUPPLIED TO CUSTOMER EITHER BY PCA DIRECTLY OR THROUGH AN AUTHORIZED DEALER OF PCA (HEREAFTER DEALER).

WHILE PCA HAS TAKEN PRECAUTIONS TO ASSURE THE CORRECTNESS OF THE ANALYTICAL SOLUTION AND DESIGN TECHNIQUES USED IN THIS SOFTWARE, IT CANNOT AND DOES NOT GUARANTEE ITS PERFORMANCE, NOR CAN IT OR DOES IT BEAR ANY RESPONSIBILITY FOR DEFECTS OR FAILURES IN STRUCTURES IN CONNECTION WITH WHICH THIS SOFTWARE IS USED. DEALER (IF ANY) HAS NOT PARTICIPATED IN THE DESIGN OR DEVELOPMENT OF THIS SOFTWARE AND NEITHER GUARANTEES THE PERFORMANCE OF THE SOFTWARE NOR BEARS ANY RESPONSIBILITY FOR DEFECTS OR FAILURES IN STRUCTURES IN CONNECTION WITH WHICH THIS SOFTWARE IS USED.

PCA AND DEALER (IF ANY) EXPRESSLY DISCLAIM ANY WARRANTY THAT: (A) THE FUNCTIONS CONTAINED IN THE SOFTWARE WILL MEET THE REQUIREMENTS OF CUSTOMER OR OPERATE IN COMBINATIONS THAT MAY BE SELECTED FOR USE BY CUSTOMER; (B) THE OPERATION OF THE SOFTWARE WILL BE FREE OF ALL "BUGS" OR PROGRAM ERRORS; OR (C) THE SOFTWARE CONFORMS TO ANY PERFORMANCE SPECIFICATIONS. CUSTOMER ACKNOWLEDGES THAT PCA IS UNDER NO OBLIGATION TO PROVIDE ANY SUPPORT, UPDATES, BUG FIXES OR ERROR CORRECTIONS TO OR FOR THE SOFTWARE OR USER DOCUMENTATION.

THE LIMITED WARRANTIES IN SECTION 7 HEREOF ARE IN LIEU OF ALL OTHER WARRANTIES, EXPRESS OR IMPLIED, INCLUDING, BUT NOT LIMITED TO, ANY IMPLIED WARRANTIES OF NON-INFRINGEMENT, MERCHANTABILITY OR FITNESS FOR A PARTICULAR PURPOSE, EACH OF WHICH IS HEREBY DISCLAIMED. EXCEPT AS SET FORTH IN SECTION 7, THE SOFTWARE AND USER DOCUMENTATION ARE PROVIDED ON AN "AS-IS" BASIS.

IN NO EVENT SHALL PCA OR DEALER (IF ANY) BE LIABLE FOR: (A) LOSS OF PROFITS, INDIRECT, INCIDENTAL, SPECIAL, EXEMPLARY, PUNITIVE, CONSEQUENTIAL OR OTHER DAMAGES, EVEN IF PCA OR DEALER (IF ANY) HAS BEEN ADVISED OF THE POSSIBILITY OF SUCH DAMAGES; (B) ANY CLAIM AGAINST CUSTOMER BY ANY THIRD PARTY EXCEPT AS PROVIDED IN SECTION 8 ENTITLED "INFRINGEMENT"; OR (C) ANY DAMAGES CAUSED BY (1) DELAY IN DELIVERY OF THE SOFTWARE OR USER DOCUMENTATION UNDER THIS AGREEMENT; (2) THE PERFORMANCE OR NONPERFORMANCE OF THE SOFTWARE; (3) RESULTS FROM USE OF THE SOFTWARE OR USER DOCUMENTATION, INCLUDING, WITHOUT

LIMITATION, MISTAKES, ERRORS, INACCURACIES, FAILURES OR CUSTOMER'S INABILITY TO PROVIDE SERVICES TO THIRD PARTIES THROUGH USE OF THE SOFTWARE OR USER DOCUMENTATION; (4) CUSTOMER'S FAILURE TO PERFORM CUSTOMER'S RESPONSIBILITIES; (5) PCA NOT PROVIDING UPDATES, BUG FIXES OR CORRECTIONS TO OR FOR ANY OF THE SOFTWARE OR USER DOCUMENTATION; (6) LABOR, EXPENSE OR MATERIALS NECESSARY TO REPAIR DAMAGE TO THE SOFTWARE OR USER DOCUMENTATION CAUSED BY (a) ACCIDENT, (b) NEGLIGENCE OR ABUSE BY CUSTOMER, (c) ACTS OF THIRD PERSONS INCLUDING, BUT NOT LIMITED TO, INSTALLATION, REPAIR, MAINTENANCE OR OTHER CORRECTIVE WORK RELATED TO ANY EQUIPMENT BEING USED, (d) CAUSES EXTERNAL TO THE SOFTWARE SUCH AS POWER FLUCTUATION AND FAILURES, OR (e) FLOODS, WINDSTORMS OR OTHER ACTS OF GOD. MOREOVER, IN NO EVENT SHALL PCA BE LIABLE FOR WARRANTIES, GUARANTEES, REPRESENTATIONS OR ANY OTHER UNDERSTANDINGS BETWEEN CUSTOMER AND DEALER (IF ANY) RELATING TO THE SOFTWARE OR USER DOCUMENTATION.

THIS AGREEMENT CONSTITUTES THE ENTIRE AND EXCLUSIVE AGREEMENT BETWEEN CUSTOMER AND PCA AND DEALER (IF ANY) WITH RESPECT TO THE SOFTWARE AND USER DOCUMENTATION TO BE FURNISHED HEREUNDER. IT IS A FINAL EXPRESSION OF THAT AGREEMENT AND UNDERSTANDING. IT SUPERSEDES ALL PRIOR COMMUNICATIONS BETWEEN THE PARTIES (INCLUDING ANY EVALUATION LICENSE AND ALL ORAL AND WRITTEN PROPOSALS). ORAL STATEMENTS MADE BY PCA'S OR DEALER'S (IF ANY) REPRESENTATIVES ABOUT THE SOFTWARE OR USER DOCUMENTATION DO NOT CONSTITUTE REPRESENTATIONS OR WARRANTIES, SHALL NOT BE RELIED ON BY CUSTOMER, AND ARE NOT PART OF THIS AGREEMENT.

I. LICENSE RESTRICTIONS

- (a) Except as expressly provided in this Agreement or as otherwise authorized in writing by PCA, Customer has no right to: (1) use, print, copy, display, reverse assemble, reverse engineer, translate or decompile the Software or User Documentation in whole or in part; (2) disclose, publish, release, sublicense or transfer to another person any Software or User Documentation; (3) reproduce the Software or User Documentation for the use or benefit of anyone other than Customer; or (4) modify any Software or User Documentation. All rights to the Software and User Documentation not expressly granted to Customer hereunder are retained by PCA. All copyrights and other proprietary rights except as expressed elsewhere in the Software or User Documentation and legal title thereto shall remain in PCA. Customer may use the Software at only one designated workstation at Customer's site at any given time. Customer may not transmit the Software electronically to any other workstation, computer, node or terminal device whether via a local area network, a wide area network, telecommunications transmission, the Internet or other means now known or hereafter created without prior written permission by PCA.
- (B) **CUSTOMER ACKNOWLEDGES THAT THE REGISTRATION PROCESS FOR THE SOFTWARE RESULTS IN THE GENERATION OF A UNIQUE LICENSE KEY AND ACTIVATION CODE PAIR. ONCE THE LICENSE KEY AND ACTIVATION CODE ARE ENTERED DURING THE INSTALLATION PROCESS, THE SOFTWARE WILL ONLY WORK ON THE COMPUTER ON WHICH THE SOFTWARE IS INITIALLY INSTALLED. IF YOU NEED TO DEINSTALL THE SOFTWARE AND REINSTALL THE SOFTWARE ON A DIFFERENT COMPUTER, YOU MUST CONTACT PCA TO OBTAIN THE NECESSARY REINSTALLATION PROCEDURES.**

2. CHARGES AND PAYMENTS

All payments for the Software and User Documentation shall be made to either PCA or Dealer (if any), as appropriate.

3. TERM AND TERMINATION

- (a) This Agreement shall be in effect from the date Customer clicks the "I AGREE" below or installs, copies or otherwise uses the Software or User Documentation until it is terminated by Customer, by Dealer (if any) on behalf of Customer or PCA or by PCA as set forth herein.
- (b) This Agreement may be terminated by PCA without cause upon 30 days' written notice or immediately upon notice to Customer if Customer breaches this Agreement or fails to comply with any of its terms or conditions. This Agreement may be terminated by Customer without cause at any time upon written notice to PCA.

4. BACKUP AND REPLACEMENT COPIES

Customer may make one copy of the Software for back-up and archival purposes only, provided PCA's copyright and other proprietary rights notices are included on such copy.

5. PROTECTION AND SECURITY

- (a) Customer shall not provide or otherwise make available any of the Software or User Documentation in any form to any person other than employees of Customer with the need to know, without PCA's written permission.
- (b) All Software and User Documentation in Customer's possession including, without limitation, translations, compilations, back-up, and partial copies is the property of PCA. Upon termination of this Agreement for any reason, Customer shall immediately destroy all Software and User Documentation, including all media, and destroy any Software that has been copied onto other magnetic storage devices. Upon PCA's request, Customer shall certify its compliance in writing with the foregoing to PCA.
- (c) Customer shall take appropriate action, by instruction, agreement or otherwise, with any persons permitted access to the Software or User Documentation, to enable Customer to satisfy its obligations under this Agreement with respect to use, copying, protection, and security of the same.
- (d) If PCA prevails in an action against Customer for breach of the provisions of this Section 5, Customer shall pay the reasonable attorneys' fees, costs, and expenses incurred by PCA in connection with such action in addition to any award of damages.

6. CUSTOMER'S RESPONSIBILITIES

The essential purpose of this Agreement is to provide Customer with limited use rights to the Software and User Documentation. Customer accepts full responsibility for: (a) selection of the Software and User Documentation to satisfy Customer's business needs and achieve Customer's intended results; (b) the use, set-up and installation of the Software and User Documentation; (c) all results obtained from use of the Software and User Documentation; and (d) the selection, use of, and results obtained from any other software, programming equipment or services used with the Software or User Documentation.

7. LIMITED WARRANTIES

PCA and Dealer (if any) warrants to Customer that: (a) PCA and Dealer (if any) has title to the Software and User Documentation and/or the right to grant Customer the rights granted hereunder; (b) the Software and User Documentation provided hereunder is PCA's most current production version thereof; and (c) the copy of the Software provided hereunder is an accurate reproduction of the original from which it was made.

8. INFRINGEMENT

- (a) PCA shall defend Customer against a claim that the Software or User Documentation furnished and used within the scope of the license granted hereunder infringes a U.S. patent or U.S. registered copyright of any third party that was issued or registered, as applicable, as of the date Customer clicked the "I AGREE" below or installed, copied or otherwise began using the Software or User Documentation, and PCA shall pay resulting costs, damages, and attorneys' fees finally awarded, subject to the limitation of liability set forth in Section 9 entitled "Limitation of Remedy," provided that:
1. Customer promptly notifies PCA in writing of the claim.
 2. PCA has sole control of the defense and all related settlement negotiations.
 3. If such claim has occurred or in PCA's opinion is likely to occur, Customer shall permit PCA at its sole option and expense either to procure for Customer the right to continue using the Software or User Documentation or to replace or modify the same so that it becomes noninfringing. If neither of the foregoing alternatives is reasonably available in PCA's sole judgment, Customer shall, on one month's written notice from PCA, return to PCA the Software and User Documentation and all copies thereof.
- (b) PCA shall have no obligation to defend Customer or to pay costs, damages or attorneys' fees for any claim based upon (1) use of other than a current unaltered release of the Software or User Documentation, or (2) the combination, operation or use of any Software or User Documentation furnished hereunder with any other software, documentation or data if such infringement would have been avoided but for the combination, operation or use of the Software or User Documentation with other software, documentation or data.
- (c) The foregoing states the entire obligation of PCA and Customer's sole remedy with respect to infringement matters relating to the Software and User Documentation.

9. LIMITATION OF REMEDY

- (a) PCA'S AND DEALER'S (IF ANY) ENTIRE LIABILITY AND CUSTOMER'S EXCLUSIVE REMEDY FOR DAMAGES DUE TO PERFORMANCE OR NONPERFORMANCE OF ANY SOFTWARE OR USER DOCUMENTATION, PCA, DEALER (IF ANY), OR ANY OTHER CAUSE WHATSOEVER, AND REGARDLESS OF THE FORM OF ACTION, WHETHER IN CONTRACT OR IN TORT, INCLUDING NEGLIGENCE, SHALL BE LIMITED TO THE AMOUNT PAID TO PCA OR DEALER (IF ANY) FOR THE SOFTWARE AND USER DOCUMENTATION.
- (b) NEITHER PCA NOR DEALER (IF ANY) IS AN INSURER WITH REGARD TO THE PERFORMANCE OF THE SOFTWARE OR USER DOCUMENTATION. THE TERMS OF THIS AGREEMENT, INCLUDING, BUT NOT LIMITED TO, THE LIMITED WARRANTIES, AND THE LIMITATION OF LIABILITY AND REMEDY, ARE A REFLECTION OF THE RISKS ASSUMED BY THE PARTIES. IN ORDER TO OBTAIN

THE SOFTWARE AND USER DOCUMENTATION FROM PCA OR DEALER (IF ANY), CUSTOMER HEREBY ASSUMES THE RISKS FOR (1) ALL LIABILITIES DISCLAIMED BY PCA AND DEALER (IF ANY) ON THE FACE HEREOF; AND (2) ALL ACTUAL OR ALLEGED DAMAGES IN EXCESS OF THE AMOUNT OF THE LIMITED REMEDY PROVIDED HEREUNDER. THE ESSENTIAL PURPOSE OF THE LIMITED REMEDY PROVIDED CUSTOMER HEREUNDER IS TO ALLOCATE THE RISKS AS PROVIDED ABOVE.

10. U.S. GOVERNMENT RESTRICTED RIGHTS

This commercial computer software and commercial computer software documentation were developed exclusively at private expense by Portland Cement Association, 5420 Old Orchard Road, Skokie, Illinois 60077. U.S. Government rights to use, modify, release, reproduce, perform, display or disclose this computer software and computer software documentation are subject to the restrictions of DFARS 227.7202-1(a) (June 1995) and DFARS 227.7202-3(a) (June 1995), or the Restricted Rights provisions of FAR 52.227-14 (June 1987) and FAR 52.227-19 (June 1987), as applicable.

11. GENERAL

- (a) No action arising out of any claimed breach of this Agreement or transactions under this Agreement may be brought by Customer more than two years after the cause of such action has arisen.
- (b) Customer may not assign, sell, sublicense or otherwise transfer this Agreement, the license granted herein or the Software or User Documentation by operation of law or otherwise without the prior written consent of PCA. Any attempt to do any of the foregoing without PCA's consent is void.
- (c) Customer acknowledges that the Software, User Documentation and other proprietary information and materials of PCA are unique and that, if Customer breaches this Agreement, PCA may not have an adequate remedy at law and PCA may enforce its rights hereunder by an action for damages and/or injunctive or other equitable relief without the necessity of proving actual damage or posting a bond therefor.
- (D) THE RIGHTS AND OBLIGATIONS UNDER THIS AGREEMENT SHALL NOT BE GOVERNED BY THE UNITED NATIONS CONVENTION ON CONTRACTS FOR THE INTERNATIONAL SALE OF GOODS, THE APPLICATION OF WHICH IS EXPRESSLY EXCLUDED, BUT SUCH RIGHTS AND OBLIGATIONS SHALL INSTEAD BE GOVERNED BY THE LAWS OF THE STATE OF ILLINOIS, APPLICABLE TO CONTRACTS ENTERED INTO AND PERFORMED ENTIRELY WITHIN THE STATE OF ILLINOIS AND APPLICABLE FEDERAL (U.S.) LAWS. UCITA SHALL NOT APPLY TO THIS AGREEMENT.
- (E) THIS AGREEMENT SHALL BE TREATED AS THOUGH IT WERE EXECUTED IN THE COUNTY OF COOK, STATE OF ILLINOIS, AND WAS TO HAVE BEEN PERFORMED IN THE COUNTY OF COOK, STATE OF ILLINOIS. ANY ACTION RELATING TO THIS AGREEMENT SHALL BE INSTITUTED AND PROSECUTED IN A COURT LOCATED IN COOK COUNTY, ILLINOIS. CUSTOMER SPECIFICALLY CONSENTS TO EXTRATERRITORIAL SERVICE OF PROCESS.

- (f) Except as prohibited elsewhere in this Agreement, this Agreement shall be binding upon and inure to the benefit of the personal and legal representatives, permitted successors, and permitted assigns of the parties hereto.
- (g) All notices, demands, consents or requests that may be or are required to be given by any party to another party shall be in writing. All notices, demands, consents or requests given by the parties hereto shall be sent either by U.S. certified mail, postage prepaid or by an overnight international delivery service, addressed to the respective parties. Notices, demands, consents or requests served as set forth herein shall be deemed sufficiently served or given at the time of receipt thereof.
- (h) The various rights, options, elections, powers, and remedies of a party or parties to this Agreement shall be construed as cumulative and no one of them exclusive of any others or of any other legal or equitable remedy that said party or parties might otherwise have in the event of breach or default in the terms hereof. The exercise of one right or remedy by a party or parties shall not in any way impair its rights to any other right or remedy until all obligations imposed on a party or parties have been fully performed.
- (i) No waiver by Customer, PCA or Dealer (if any) of any breach, provision, or default by the other shall be deemed a waiver of any other breach, provision or default.
- (j) The parties hereto, and each of them, agree that the terms of this Agreement shall be given a neutral interpretation and any ambiguity or uncertainty herein should not be construed against any party hereto.
- (k) If any provision of this Agreement or portion thereof is held to be unenforceable or invalid by any court or competent jurisdiction, such decision shall not have the effect of invalidating or voiding the remainder of this Agreement, it being the intent and agreement of the parties that this Agreement shall be deemed amended by modifying such provision to the extent necessary to render it enforceable and valid while preserving its intent or, if such modification is not possible, by substituting therefor another provision that is enforceable and valid so as to materially effectuate the parties' intent.

Except as set forth herein, this Agreement may be modified or amended only by a written instrument signed by a duly authorized representative of PCA and Customer.

Table of Contents

License Agreements	ii
Chapter 1 – Introduction.....	1-1
Terms.....	1-1
Conventions.....	1-2
System Requirements	1-2
Minimum Requirements.....	1-2
Recommended Options.....	1-3
Program Capacity	1-3
Installing Pcawall	1-4
Purchasing And Licensing Process.....	1-8
Licensing Model.....	1-8
Evaluation Mode	1-9
How To Purchase	1-9
Licensing Activation	1-9
Activation By Phone.....	1-12
Activation By E-Mail	1-13
Chapter 2 – Method of Solution	2-1
The Global Coordinate System.....	2-2
Mesh Generation	2-2
Preparing The Input.....	2-4
The Plate Element.....	2-5
The Stiffener Element.....	2-7
Cracking Coefficients	2-8
Types Of Loads	2-9
Point Loads.....	2-9
Line Load	2-11
Uniform Area Loads.....	2-11
Linear Area Loads	2-12
Selfweight.....	2-13
Load Cases And Load Combinations	2-14

Nodal Restraints And Nodal Springs	2-14
The Solution.....	2-15
Element Design Forces	2-16
Plate Elements.....	2-16
Stiffener Elements.....	2-18
Required Reinforcement	2-18
Flexural Design	2-19
Shear Design Of Stiffener Elements	2-20
Program Results	2-20
Nodal Displacements:	2-21
Reactions:.....	2-21
Element Internal Forces:	2-21
Displacement Envelopes:	2-21
Element Reinforcement:.....	2-21
References.....	2-22
 Chapter 3 – The pcaWall Interface	 3-1
Control-Menu:.....	3-2
Title Bar:	3-2
Min/Max/Close Buttons:.....	3-2
Tool Bar:	3-3
Menu Bar:	3-3
Status Bar:.....	3-3
Tabs (On Main Window):	3-3
Graphics/Input Area (On Main Window):	3-3
Item Listing Area (On Main Window):.....	3-3
Information Area (On Main Window):	3-4
Using The Menus	3-4
Menu Conventions	3-4
Using A Dialog Box.....	3-4
Using The Tool Bar.....	3-6
Working With A List Box.....	3-9
To Select A Single Item From A List Box:.....	3-9
To Select Multiple Sequential Items In A List:.....	3-9
To Select Multiple Non-Sequential Items In A List:.....	3-10
Working With A Drop-Down List	3-10
Working With A Text Box.....	3-11
Using A Command Button.....	3-11
Using A Radio Button.....	3-11
Using A Check Box	3-11

File Menu	3-12
New	3-12
Open	3-12
Save	3-12
Save As.....	3-12
Revert	3-12
Print Results	3-12
Print Screen	3-12
Exit	3-12
Define Menu.....	3-13
Project Description	3-13
Grid.....	3-13
Properties.....	3-13
Supports.....	3-14
Loads	3-14
Load Combinations	3-15
Assign Menu.....	3-15
Properties.....	3-15
Supports.....	3-16
Loads	3-16
Solve Menu.....	3-17
Run Analysis & Design	3-17
Run Design	3-17
View Results.....	3-17
View Contours.....	3-17
View Diagram	3-17
View Menu	3-17
Status Bar	3-17
This Menu (Ctrl+F12)	3-17
Reset	3-18
Zoom-In.....	3-18
Zoom-Out	3-18
Pan.....	3-18
Options Menu	3-18
Startup Defaults	3-18
Autosave.....	3-18
Display Preferences	3-18
Help Menu.....	3-19
Help Topics	3-19
About PcaWall	3-19

Chapter 4 – Operating pcaWall.....	4-1
Creating A New Data File.....	4-1
Opening An Existing Data File	4-2
Saving The Data.....	4-2
To Save Your Data With The Same Filename:	4-3
To Save Your Data For The First Time Or To Give An Existing Data File A New Filename:.....	4-3
Reverting To The Last Saved Data File	4-3
Printing Results	4-4
Printing The Screen.....	4-6
Exiting The Program.....	4-6
Defining The Project Description	4-7
Defining The Grid.....	4-7
To Enter Grid Lines Individually:.....	4-8
To Delete Grid Lines:.....	4-9
To Edit The Position Of A Grid Line:.....	4-9
To Generate Grid Lines:.....	4-9
To Remove All The Grid Lines:	4-10
To Choose The Grid View Preferences:.....	4-10
To View The Grid Coordinates:.....	4-10
Defining Properties	4-11
To Define Plate Element Thickness:	4-12
To Define Stiffener Element Section:	4-13
To Define Plate Cracking Coefficients:	4-14
To Define Stiffener Cracking Coefficients:	4-14
To Define Concrete Properties:.....	4-15
To Define Reinforcing Steel Properties:	4-16
To Define Plate Design Criteria:.....	4-16
To Define Stiffener Design Criteria:	4-17
Defining Supports	4-19
To Define Rigid Supports:	4-19
To Define Spring Supports:	4-20
Defining Loads.....	4-21
To Define Point Loads:	4-21
To Define Uniform Area Loads:	4-22
To Define Linear Area Loads:	4-23
To Define Uniform Line Loads:.....	4-24
Defining Load Combinations.....	4-25
To Define Service Load Combinations:.....	4-25
To Define Ultimate Load Combinations:.....	4-26

Assigning Properties.....	4-27
To Assign Plate Element Thickness:	4-27
To Assign Plate Cracking Coefficient:	4-28
To Assign Plate Concrete Material:.....	4-28
To Assign Plate Reinforcing Steel Material:	4-29
To Assign Plate Design Criteria:	4-30
To Assign Stiffener Element Section:	4-30
To Assign Stiffener Cracking Coefficient:	4-31
To Assign Stiffener Concrete Material:.....	4-31
To Assign Stiffener Reinforcing Steel Material:	4-32
To Assign Stiffener Design Criteria:	4-32
Assigning Supports.....	4-33
To Assign Rigid Supports:	4-34
To Assign Spring Supports:.....	4-34
Applying Loads	4-35
To Assign Point Loads:	4-35
To Assign Uniform Area Loads:	4-36
To Assign Linear Area Loads:.....	4-37
To Assign Uniform Line Loads:.....	4-37
Solving The Structural Model	4-38
Viewing Results	4-39
Viewing Contours.....	4-43
Viewing Diagrams.....	4-44
Defining The Options	4-46
To Define Startup Defaults:.....	4-46
To Control The Autosave Feature:	4-47
To Customize The Display:.....	4-47
Chapter 5 – Examples.....	5-1
Example 1.....	5-1
Inputting Problem Databases.....	5-2
Assigning Properties.....	5-8
Assigning Loads	5-8
Solving.....	5-10
Viewing And Printing Results	5-11
Example 2.....	5-13
Inputting Problem Databases.....	5-14
Assigning Properties.....	5-18
Assigning Loads	5-18
Solving.....	5-19

Viewing And Printing Results	5-20
References	5-21
Appendix.....	A-1
Code Provisions	A-1
Flexure Design	A-1
Shear And Torsion Design	A-2
Conversion Factors - English To SI	A-6
Conversion Factors - SI To English.	A-6
Contact Information	A-7
Bug Report Form	A-8

Chapter 1

Introduction

Terms

The following terms are used throughout this manual. A brief explanation is given to help familiarize you with them.

Windows	refers to the Microsoft Windows environment version 3.1 or higher.
[]	indicates metric equivalent
Click on	means to position the cursor on top of a designated item or location and press and release the left-mouse button (unless instructed to use the right-mouse button).
Double-click on	means to position the cursor on top of a designated item or location and press and release the left-mouse button twice in quick succession.
Marquee select	means to depress the mouse button and continue to hold it down while moving the mouse. As you drag the mouse, a rectangle (known as a marquee) follows the cursor. Release the mouse button and the area inside the marquee is selected.

Conventions

Various styles of text and layout have been used in this manual to help differentiate between different kinds of information. The styles and layout are explained below...

<i>Italic</i>	indicates a glossary item, or emphasizes a given word or phrase.
Bold	All bold typeface makes reference to either a menu or a menu item command such as File or Save , or a tab such as Description or Grid
Mono-space	indicates something you should enter with the keyboard. For example type "c:*.txt".
KEY + KEY	indicates a key combination. The plus sign indicates that you should press and hold the first key while pressing the second key, then release both keys. For example, "ALT + F" indicates that you should press the "ALT" key and hold it while you press the "F" key. then release both keys.
SMALL CAPS	Indicates the name of an object such as a dialog box or a dialog box component. For example, the OPEN dialog box or the CANCEL or MODIFY buttons.

System requirements

To use pcaWall, a personal computer with one of the following operating systems is required...

- Microsoft Windows 98 or later
- Windows ME
- Windows XP
- Windows NT
- Windows 2000 Server.

Minimum Requirements

- 32 MB of RAM
- CD-ROM drive

- 50 MB free space on hard drive
- A mouse or other pointing device

Recommended Options

A printer supported by one of the operating systems listed above.

Program Capacity

- 255 X-grid lines
- 255 Y-grid lines
- 255 Plate thickness definitions
- 255 Stiffener section definitions
- 255 Plate cracking coefficient definitions
- 255 Stiffener cracking coefficient definitions
- 255 Concrete definitions
- 255 Steel definitions
- 255 Plate design criteria definitions
- 255 Stiffener design criteria definitions
- 255 Rigid support definitions
- 255 Spring support definitions
- 255 Point load definitions per load case
- 255 Uniform area load definitions per load case
- 255 Linear area load definitions per load case
- 255 Uniform line load definitions per load case
- 255 Service Load combinations
- 255 Ultimate Load combinations
- Approximately 10,000 nodes and 10,000 elements

Installing pcaWall

1. If you have the installation disk please insert it into the CD drive and proceed to step 2. If you do not have the installation disk but downloaded the installation file from our website, please run the file and proceed to step 3.
2. If the installation does not start automatically after inserting the installation disk to the CD drive then please run the file install.exe from the installation disk and proceed to step 3. If the installation starts automatically then please follow the instructions on the screen. You may be asked which product you want to install if you received pcaWall together with other software from pcaStructurePoint.
3. The installation process starts by displaying the following window (Figure 1-1). Please read all the information. Then press the NEXT button. This will continue the installation process by installing license manager, an evaluation license, and the application software.

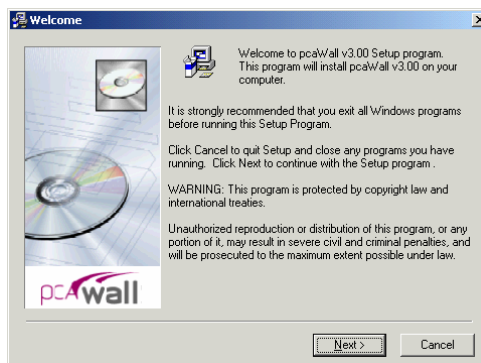

Figure 1-1. Beginning of the installation

4. The first step of the application installation process is to review the software license agreement as shown in Figure 1-2. Please read all the information carefully. Press the I AGREE button to confirm that you have read and agreed with it. This will continue the installation. If you do not agree with the license agreement press the I DO NOT AGREE button. This will stop the installation.

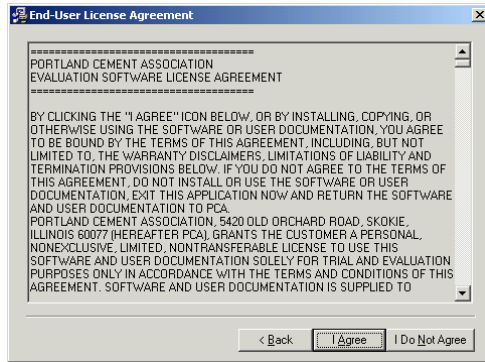

Figure 1-2. License agreement

5. If you continue the installation then please read the latest information of the software included in the readme file (Figure 1-3). Having read all the information press the NEXT button.

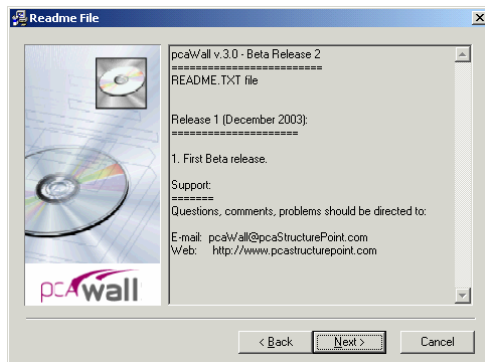

Figure 1-3. Readme file

6. In the next step please provide the user's name and company. Press next when you are ready to proceed.



Figure 1-4. Registration information

7. The next setup is to decide the directory where pcaWall is to be installed as shown in Figure 1-5. The default one is C:\Program Files\PCA\pcaWall. You may press the BROWSE button to locate the directory. If the directory does not exist, the setup program will create it. Press the NEXT button to go to the next step.

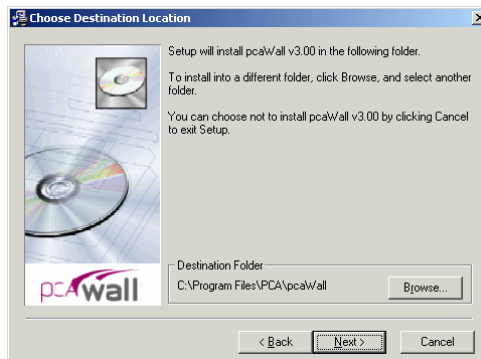

Figure 1-5. Choose Destination Location

8. The next step is to enter the group name as shown in Figure 1-6. Windows will use this name in the Start/Programs menu. Press the NEXT button to go to the next step.

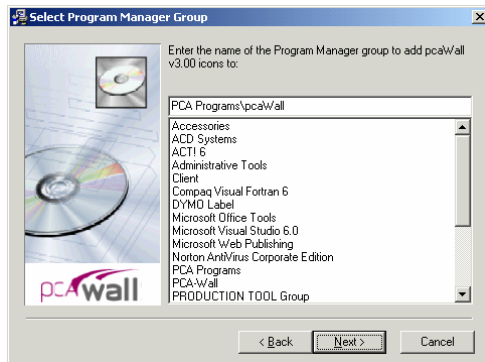

Figure 1-6. Select Program Manager Group

9. After all the previous steps are completed, press the NEXT button as shown in Figure 1-7 to start the installation.

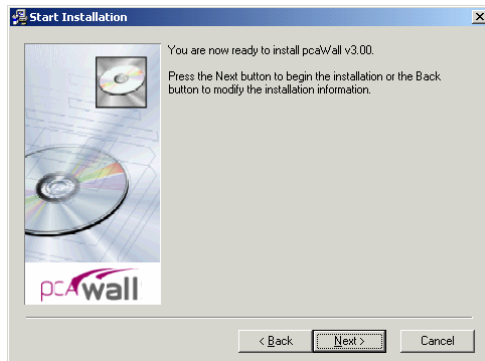

Figure 1-7. Start Installation

10. During the installation a window as in Fig. 1-8 shows the progress as files are copied to your hard drive.

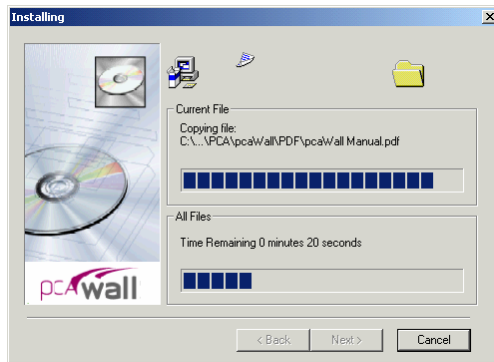

Figure 1-8. Installation progress

11. After the installation is completed, a dialog box similar to Figure 1-9 is shown. Press the FINISH button to finish the installation.

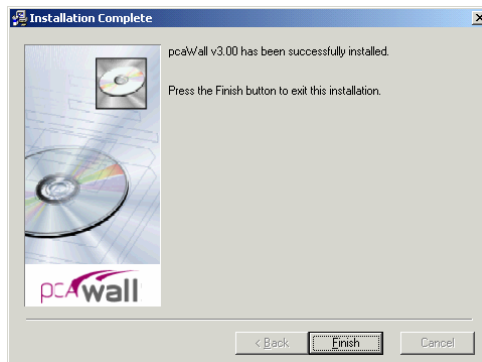

Figure 1-9. Installation Complete

Purchasing and Licensing Process

Licensing Model

By default, each pcaStructurePoint software application comes in an Evaluation mode. This means that initially our products can be used for a limited time of 15 days. If the user decides to purchase the software license, and completes the purchase, pcaStructurePoint will provide a License Code. By entering this code, user will activate the software license. Once the software license is activated the application will no longer have restrictions limiting the time of operation.

Evaluation Mode

This is the default mode of the license. In this licensing scheme, users are granted limited rights to use our full-featured software. The only visible difference between the evaluation version and the licensed version is an additional start-up dialog box as shown in Figure 1-8. It gives a choice of buying the software, entering the activation code or running the application in the evaluation mode by pressing the EVALUATE button. Evaluation mode is available for a limited time only. By default, pcaStructurePoint software applications come with 15 days. That means, from the day of installation, a user can evaluate the software for the next 15 days. After this time, user will either obtain a License, or uninstall the application.

Note: Any tampering with system clock or evaluation license file will render the software useless.

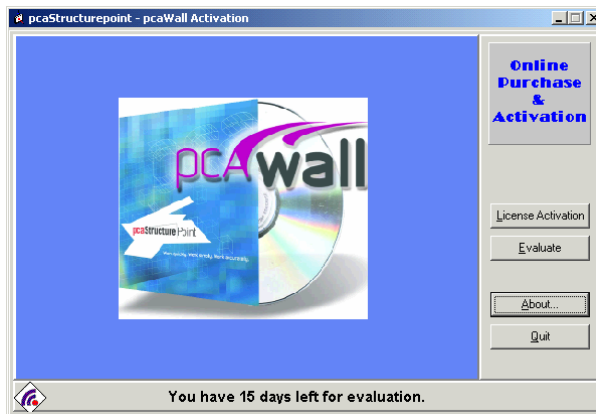

Figure 1-8. Start-up Dialog Box

How to Purchase

You may purchase the license on-line at www.pcaStructurePoint.com or by calling our Sales Department at 847-972-9042. To buy on-line you may press BUY NOW button, which will run your default web browser and open the product web page where you will be able to complete the transaction.

Licensing Activation

After the purchase is completed, pcaStructurePoint will generate a unique Activation Code based on the product ID and the locking code, which is derived from the unique hardware-id of the user's computer. Each License is associated

with the particular PC in which user has installed the pcaStructurePoint software. This implies that the activation-code will not work on any other PC. You can transfer the license to another PC by contacting pcaStructurePoint for the transfer procedures.

To activate the license press the LICENSE ACTIVATION button in the start-up dialog box. This will bring a window as in Figure 1-9, which shows three license activation methods.

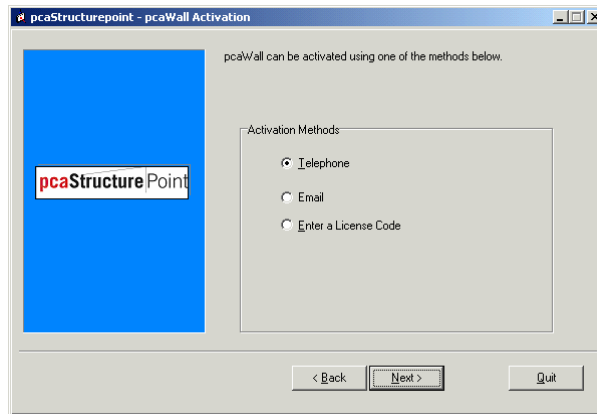

Figure 1-9. License activation methods

If you have already received the license code you may choose ENTER LICENSE CODE and then press the NEXT button. A window (Figure 1-9) will pop up where you will be able to type in the license code. However, in order to avoid mistyping we advise to use copy and paste feature instead of typing the code.

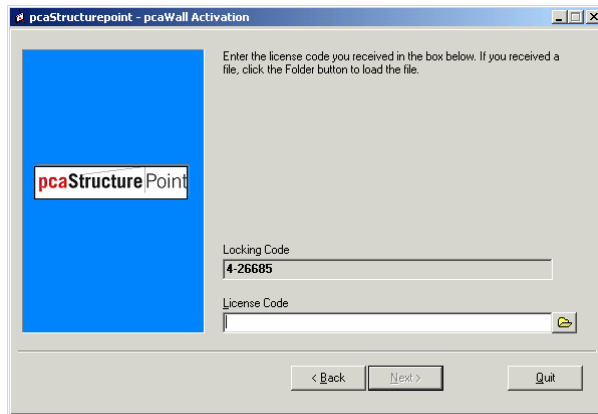



Figure 1-9. Enter license code

The license code can also be extracted from a file. To do that press the BROWSE button  and open the file in which the license code is stored using the open window (Figure 1-10).

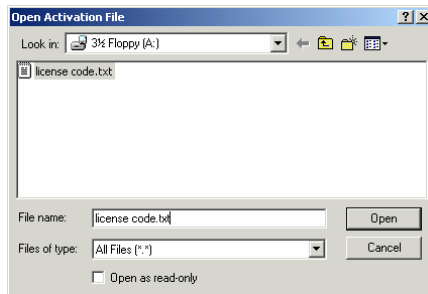

Figure 1-10. Open activation file

If the entered code is correct the license will be activated and window as in Figure 1-11 will show. When you press the FINISH button the license activation will be completed.

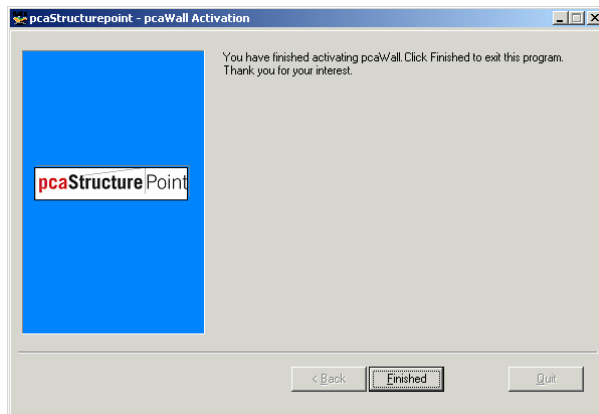

Figure 1-11. Activation completion

If you do not have the license code you may choose either TELEPHONE or E-MAIL method, whichever is more convenient for you. Please note that for E-MAIL method you need to have the Internet connection and a default mailer configured in your system.

Activation by Phone

If the telephone method was chosen to activate the license the following screen appears (Figure 1-12). It shows the product ID and the Locking Code.

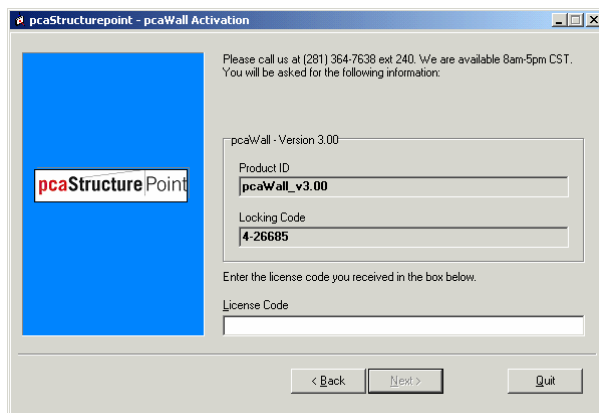

Figure 1-12. Activation by phone

This information is needed when you make a phone call at 847-966-4357 (HELP) to obtain the license. You will be asked to provide information about yourself in order to verify that you have purchased the license.

Activation by E-mail

If the e-mail method was chosen to activate the license a screen (Figure 1-13) will show prompting you to provide information about yourself. When you type in all the information press the SEND E-MAIL button and it will be automatically e-mailed to us together with the product ID and the Locking Code. After the information is verified the license code will be generated and e-mailed back to you.

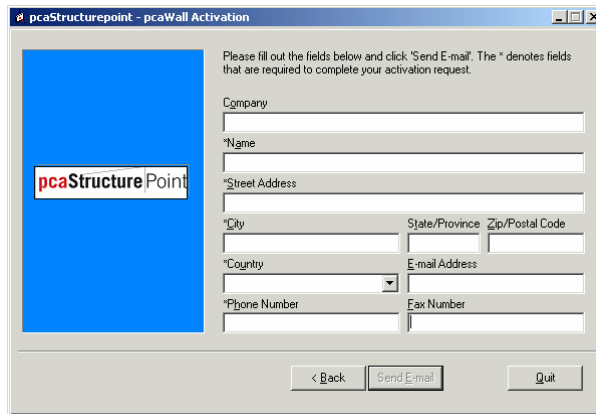

Figure 1-13. Activation by e-mail

After you receive it you may enter it by pressing the LICENSE ACTIVATION button in the start up dialog box (Figure 1-8) and choosing ENTER LICENSE CODE option. . If the entered code is correct, the license will be activated and window as in Figure 1-11 will show. When you press the FINISH button the license activation will be completed.

Chapter 2

Method of Solution

pcaWall uses the Finite Element Method for the structural modeling and analysis of slender reinforced concrete walls subject to static loading conditions. The wall is idealized as a mesh of rectangular plate elements as well as straight- line stiffener elements. Walls of irregular geometry should be idealized to conform to geometry with rectangular boundaries. Plate and stiffener properties can vary from one element to another but are assumed uniform within each element.

Six degrees of freedom exist at each node: three translations and three rotations relating to the three Cartesian axes. An external load can exist in the direction of each of the degrees of freedom. Sufficient number of nodal degrees of freedom should be restrained in order to achieve structural stability.

The program assembles the global stiffness matrix and load vectors for the finite element model. Then, it solves the equilibrium equations to obtain deflections and rotations at each node. Finally, the program calculates the internal forces and internal moments in each element. At the users option, the program can perform second order analysis. In this case, the program takes into account the effect of in-plane forces on the out-of-plane deflection.

In the design mode, the program calculates the required amount of reinforcement in the plate elements and stiffener elements.

The Global Coordinate System

The mid-surface of the wall lies in the XY plane of the right-handed XYZ rectangular coordinate system shown in Figure 2-1. The wall thickness is measured in the direction of the Z-axis. The positive X-axis points to the right, the positive Y-axis points upward towards the top of the monitor, and positive Z-axis points out of the screen. Thus, the XY plane is defined as being in the plane of the display monitor.

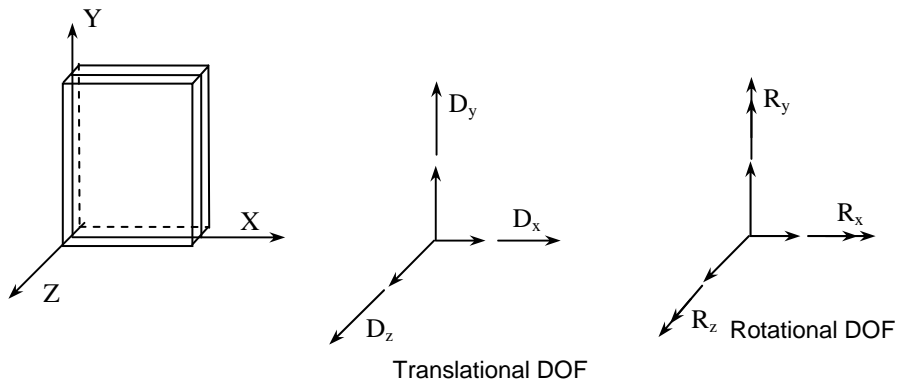

Fig. 2-1. The Global Coordinate System

Mesh Generation

The nodal coordinates of the finite element mesh are internally computed by the program based on the rectangular grid system shown in Figure 2-2. A group of grid lines, orthogonal to the X and Y axes, are defined by inputting their coordinates. An X-grid line is a vertical line defined by its distance from the origin along the X-axis and a Y-grid line is a horizontal line defined by its distance from the origin along the Y-axis.

The intersection of two orthogonal grid lines forms a grid intersection. The space formed by the intersection of two consecutive X-grid lines and two consecutive Y-grid lines is a grid space. Assigning plate thicknesses to the grid spaces automatically creates plate finite elements in these grid spaces. The assembling of stiffener elements to the wall system is done by assigning stiffener element section to the lines defined by the connection of two consecutive grid intersections in the X or Y directions.

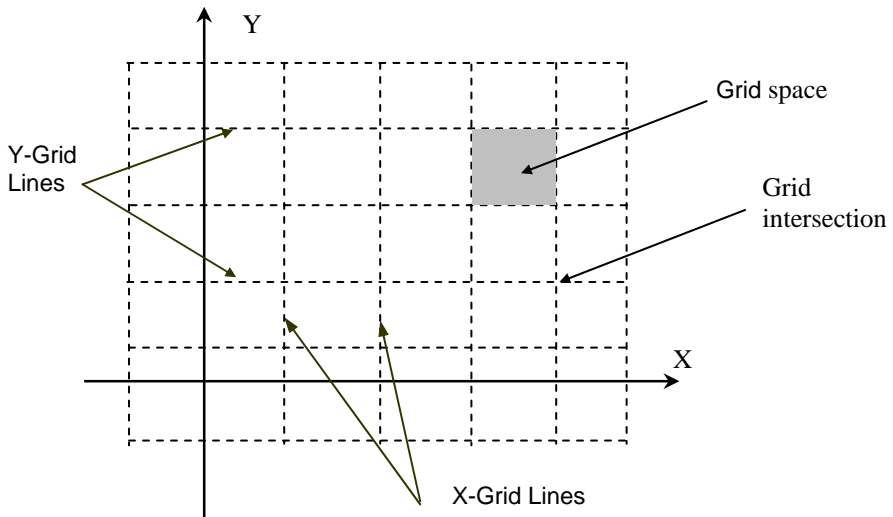

Fig. 2-2. The Grid System

Preparing the Input

The first step in preparing the input is to draw a scaled elevation view of the wall. The elevation view should include the boundaries of the wall, variations in the wall thickness, material properties, stiffener locations, and openings within the wall. All superimposed loads applied on the wall should also be shown.

Superimpose a rectangular grid system over the elevation of the wall. The following factors control the grid layout:

1. Grid lines must exist along wall boundaries and openings. Wall boundaries not parallel to the X- or Y-axis may be defined by steps that approximate the sloped boundary.
2. Grid lines must exist along the boundaries of wall thickness changes, wall material property changes, design criteria changes, and stiffener locations.
3. Grid lines must exist along boundaries of area loads.
4. Grid lines must exist along line loads.
5. Grid intersections must exist at locations of point loads and supports.

The above guidelines basically form the major grid lines which produce the minimum number of finite elements for the particular wall geometry. The mesh can be refined by supplementing the model with minor grid lines between the major grid lines. Minor grid lines need to be added to achieve a uniform, well-graded mesh that produces results which effectively capture the variations of the displacements and element forces. The location of the minor grid lines also depends on the level of accuracy that is desired from the analysis.

While the use of finer meshes will generally produce more accurate results, it will also require more solution time, computer memory, and disk space. For wall regions where heavy concentrated forces are applied and anywhere drastic changes in geometry exist, the use of finer element meshes may be required. Thus, in order to obtain a practical as well as an accurate analytical solution, engineering judgment must be used.

The element nodal incidences are internally computed by the program. All nodes and elements are numbered from left to right (in the positive X-direction) and from bottom to top (in the positive Y-direction), as shown in Figure 2-3. When the reference grid system and/or assembling of elements is modified, all node and element numbers are internally modified by the program.

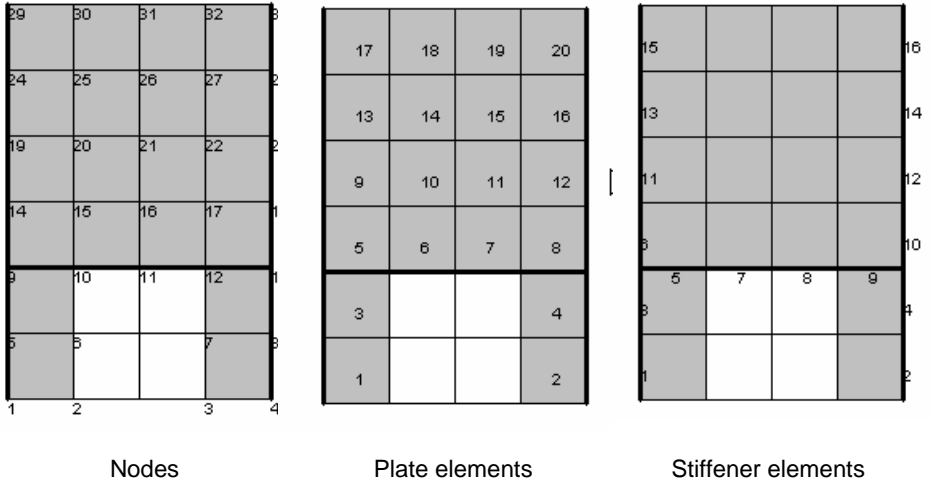

Fig. 2-3. Node and Element Numbering

The Plate Element

The rectangular plate finite element has four nodes, one at each corner, as shown in Figure 2-4. Each node has six degrees of freedom (D_x , D_y , D_z , R_x , R_y , and R_z). The rotation, R_z , is referred to as the drilling rotation (ref. 1).

The plate element combines the membrane (in plane) and bending (out of plane) actions. Element stiffness is calculated based on the following assumptions:

1. The x-y plane is the mid surface of the plate element.
2. Deformations are small and the resulting displacements do not significantly change the geometry of the wall.
3. The membrane and bending deformations are uncoupled.
4. Bending behavior follows the thin plate theory (Kirchhoff theory).
5. Plane sections initially normal to the mid-surface remain plane and normal to that surface after bending.
6. The stress component normal to the mid-plane is small compared to other stress components and is neglected.
7. The plate element material is homogeneous, elastic, isotropic, and obeys Hooke's law.

If second order analysis is requested, the stiffness terms related to the bending action are modified to include the effect of in-plane internal forces (ref. 1).

When locating reinforcement within a plate element, the program refers to the left face and right face. The left face of the panel is defined as the face to the left of the plate centerline when looking along the positive X-axis. See Figure 2-4.

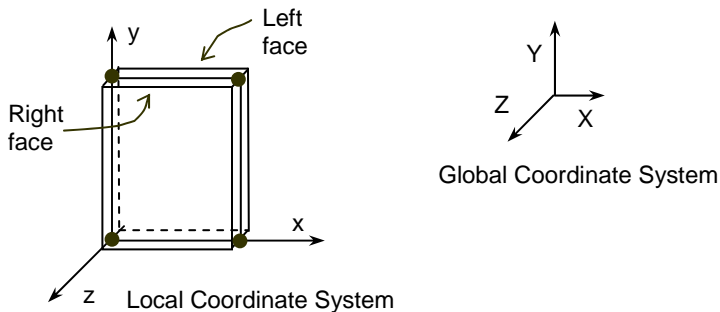

Fig. 2-4. The Plate Element

The Stiffener Element

The stiffener element used in the program has two nodes, one at each end, as shown in Figure 2-5. Each node has six degrees of freedom (D_x , D_y , D_z , R_x , R_y , and R_z). Element stiffness is calculated based on the following assumptions:

1. The local x-axis passes through the element centroid.
2. Deformations are small and the resulting displacements do not significantly change the geometry of the wall.
3. Axial and bending deformations are uncoupled.
4. Plane sections initially normal to the element axis remain plane and normal to that axis after bending.
5. The stiffener element material is homogeneous, elastic, isotropic, and obeys Hooke's law.

If second order analysis is requested, the stiffness terms related to the bending about the Y-axis are modified to include the effect of the axial force (ref. 2).

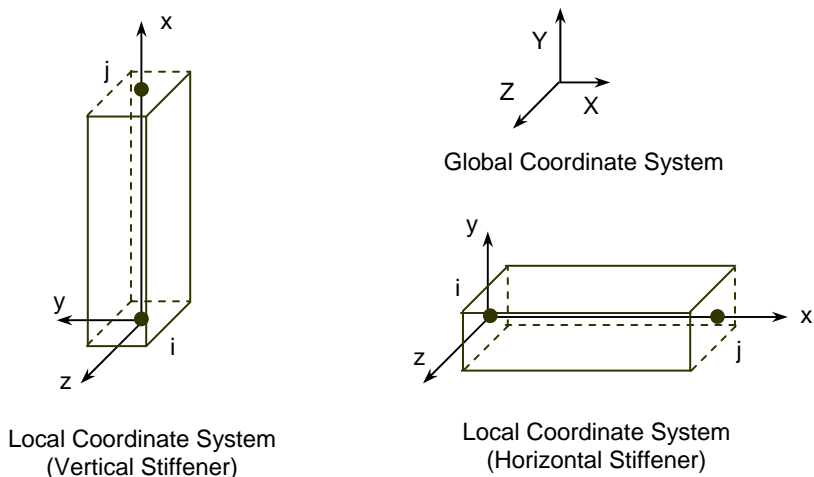

Fig. 2-5. The Stiffener Element

The properties of the stiffener section, area (A), Inertia (I_y , I_z) and torsional constant (J) are calculated as follows:

$$A = \begin{cases} bh & \text{rectangular section} \\ \pi D^2 & \text{circular section} \end{cases}$$

I_y = Inertia of the web and the flanges about the centroidal local y-axis.

$$I_z = \begin{cases} \frac{hb^3}{12} & \text{rectangular section} \\ \frac{\pi D^4}{64} & \text{circular section} \end{cases}$$

$$J = \frac{W_{fl}t_{fl}^3}{3} + \frac{W_{fr}t_{fr}^3}{3} + \begin{cases} \frac{bh^3}{3} (b > h) & \text{rectangular section} \\ \frac{hb^3}{3} (h > b) & \text{rectangular section} \\ \frac{\pi D^4}{32} & \text{circular section} \end{cases}$$

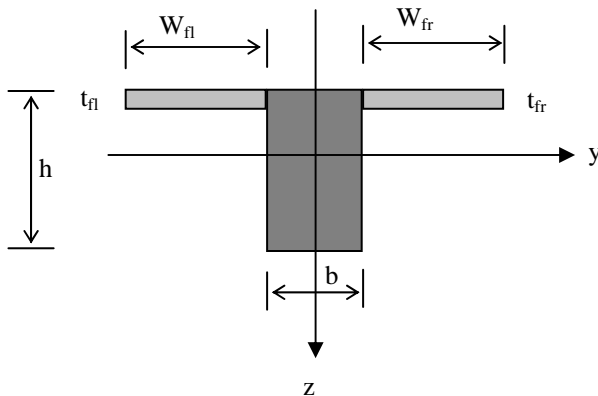

Cracking Coefficients

To account for cracking of elements, the user can input cracking coefficient values for plate and stiffener elements to effectively reduce stiffness. Cracking coefficients for out-of-plane (bending and torsion) and in-plane (axial and shear) stiffness can be entered for plate elements. Cracking coefficients for A, I_z , I_y , and J can be entered for stiffeners. Because the values of the cracking coefficients can have a large effect on the analysis and design results, the user must take care in selecting values that best represent the state of cracking at the particular loading stage. Typically, crack coefficients are greater than 0 and less than 1.

At ultimate loads, a wall is normally in a highly cracked state. The user could enter a value for out-of-plane cracking coefficient for plates and I_z and I_y cracking coefficients for stiffeners of $I_{cracked}/I_{gross}$ based on estimated values of A_s . After the analysis and design, if the computed value of A_s greatly differs from the estimated value of A_s , the analysis should be performed again with new values for the crack coefficients.

At service loads, a wall may or may not be in a highly cracked state. For service load deflection analysis, a problem should be modeled with an out-of-plane cracking coefficient for plates and I_z and I_y cracking coefficients for stiffeners of $I_{effective}/I_{gross}$. $I_{effective}$ is a value between $I_{cracked}$ and I_{gross} . ACI 318 gives some guidance for calculating $I_{effective}$ for bending members.

Types of Loads

An external load is applied as a point load, a line load or an area load. Positive forces are defined as forces in the positive direction of the global axes, and positive moments are defined in accordance with the right hand rule. In other words, if the thumb of your right hand points in the positive direction of an axis, curling the rest of your right-hand fingers defines the positive moment about that axis.

Point Loads

A point load consists of three forces P_x , P_y , and P_z and three moments M_x , M_y , and M_z corresponding to the six DOF at each node. Point forces have units of force, and point moments have units of force times length. Point forces and point moments must be applied at a node. In addition to point moments, an eccentricity in the Z-direction, E_z , can be input. P_x and P_y values are multiplied by E_z to obtain additional point moments (Figure 2-6). Thus, the final moments at a node are:

$$M_x = \bar{M}_x - E_z P_y \text{ and } M_y = \bar{M}_y + E_z P_x ,$$

where \bar{M}_x and \bar{M}_y are the moment input by the user about the X and the Y axes respectively.

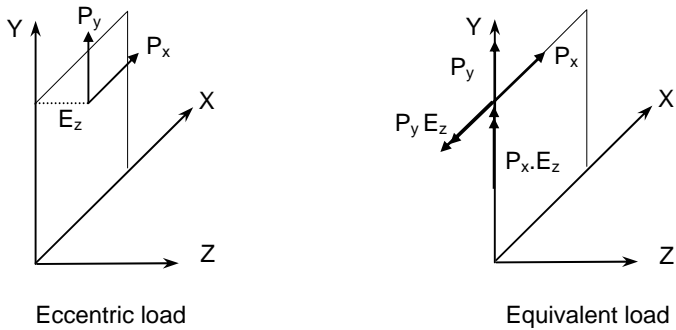

Fig. 2-6. Eccentric point load

Line Load

A line load consists of three uniformly distributed line loads W_x , W_y , and W_z corresponding to the three translational DOF at each node and an eccentricity in the Z-direction, E_z . Line loads must be applied along the boundary of a plate element or along a stiffener element. W_x , W_y , and W_z have units of force per unit length. Internally in the program, lumped-nodal loads replace the line load as follows (Figure 2-7):

$$\begin{Bmatrix} P_x \\ P_y \\ P_z \end{Bmatrix} = \frac{L}{2} \begin{Bmatrix} W_x \\ W_y \\ W_z \end{Bmatrix}$$

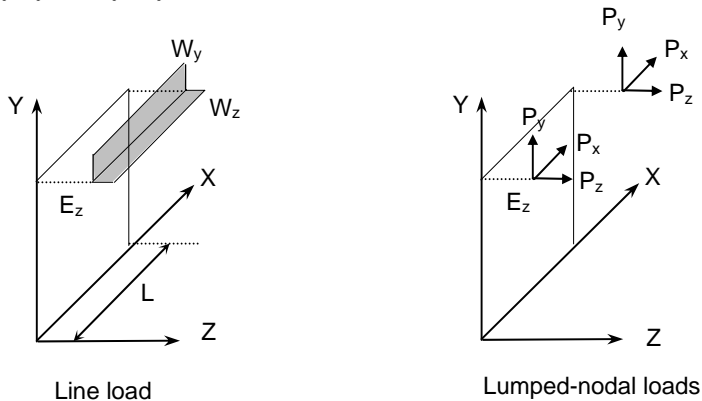

Fig. 2-7. Line load

Uniform Area Loads

A uniform area load consists of three uniformly distributed loads, W_x , W_y and W_z corresponding to the three translational DOF. Area loads are applied over the area of plate elements. W_x , W_y and W_z have units of force per unit area. Internally in the program, lumped-nodal loads replace the uniform area load as follows (Figure 2-8):

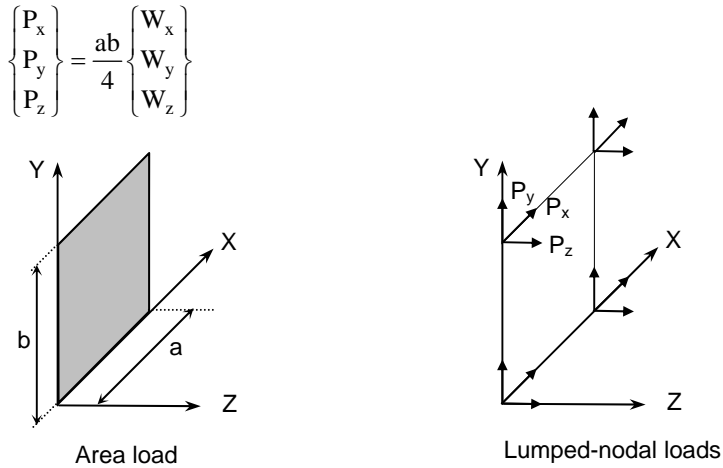

Fig. 2-8. Line load

Linear Area Loads

Linear area loads are used to represent water and earth pressure. The load is defined as linearly varying in the Y direction and uniform in the X direction (Figure 2-9). The load values are defined at two points, along the Y-direction, whose Y-coordinates are denoted Y_1 and Y_2 respectively. The load values are denoted W_{x1} , W_{y1} , and W_{z1} at Y_1 while they are denoted W_{x2} , W_{y2} , and W_{z2} at Y_2 .

The load is applied to an element as uniform area load intensity of which is calculated as follows:

$$\begin{Bmatrix} W_x \\ W_y \\ W_z \end{Bmatrix} = \frac{(Y_2 - Y)}{(Y_2 - Y_1)} \begin{Bmatrix} W_{x1} \\ W_{y1} \\ W_{z1} \end{Bmatrix} + \frac{(Y - Y_1)}{(Y_2 - Y_1)} \begin{Bmatrix} W_{x2} \\ W_{y2} \\ W_{z2} \end{Bmatrix}$$

where Y is the Y-coordinate of the element center.

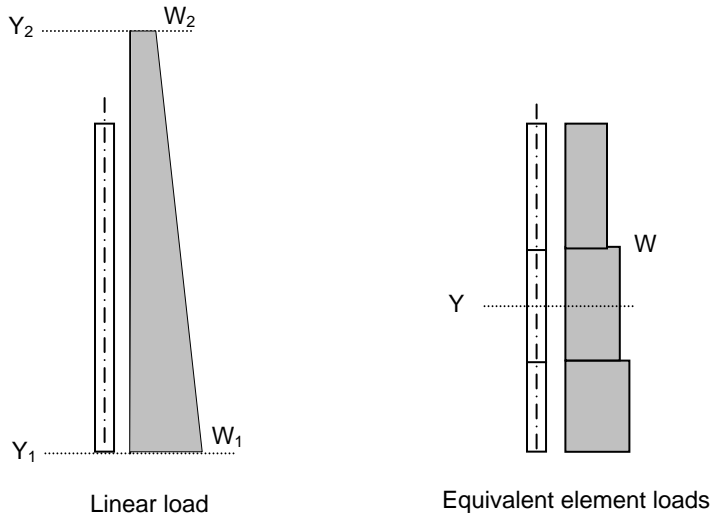

Fig.2.9-Linear Area load

SelfWeight

The self weight of the wall is computed internally based on the concrete unit weight and the thickness of each plate element or volume of each stiffener element. For plate elements, the value of self-weight is applied as a uniform area load in the Y-direction. For stiffener element, the value of self-weight is applied as a uniform line load in the Y-direction. The self-weight may optionally be included in the analysis in load case A.

Load Cases and Load Combinations

Applied loads are categorized into six load cases: A, B, C, D, E, and F. Any number of load types can be applied to the wall under each load case. Load cases are combined for load combinations. A load combination is the algebraic sum of each of the load cases multiplied by a load factor. The wall is analyzed and designed for each load combination.

Load combinations are categorized into Service level and Ultimate level. For each Service and Ultimate level combination, the nodal deflections and reactions are calculated. Element internal forces are calculated for each ultimate level combination.

For the design of reinforced concrete elements, the required area of steel is calculated due to the element internal forces belonging to ultimate load combinations. On the other hand, displacement envelopes are determined using the displacement belonging to service load combinations.

Nodal Restraints and Nodal Springs

All nodal degrees-of-freedom (DOF) are assumed to be initially released (i.e. free to move.) Mathematically speaking, each DOF implies an equilibrium equation; however, nodal DOF may be fully restrained against displacement and/or rotation. This allows the definition of wall supports. For equilibrium to exist, the wall must be restrained such that structure stability is achieved.

Nodal DOF can be partially restrained by defining spring supports. Spring constants corresponding to the six DOF can be defined at any node. The spring supports are idealized as linear springs. Units of the spring constant are in terms of force per unit length for translational springs and moment per radian for rotational springs.

The Solution

The solution process is summarized in the following steps:

A. Perform in-plane analysis:

1. Compute the plate and stiffener element matrices related to the in-plane degrees of freedom ($\delta_x, \delta_y, \theta_z$).
2. Assemble the in-plane global stiffness matrix, $[K_i]$.
3. Combine the applied loads and form number of load vectors equal to the number of load combinations, $[F_i]$.
4. Compute the displacement $[U_i]$, by solving the equilibrium equations:
 $[K_i][U_i]=[F_i]$
 This gives the in-plane displacements at each node.
5. Compute the plate element in-plane forces N_{xx} , N_{yy} , and N_{xy} .
6. Compute the stiffener element in-plane end forces F_x , F_y , and M_z .
7. Compute the reaction forces F_x , F_y , and M_z at each restrained node.

B. Perform out-of-plane analysis:

1. If first order analysis is requested, the out-of-plane analysis is done once for all load combinations in a similar way to that done for the in-plane analysis.
2. Out-of-plane analysis gives:
 - i- the displacements ($\delta_z, \theta_x, \theta_y$) at each node,
 - ii- the reaction forces F_z , M_x , and M_y at each restrained node,
 - iii- the plate element internal moments M_{xx} , M_{yy} , M_{xy} ,
 - iv- the stiffener element end forces F_z , M_x , and M_y .
3. If second order analysis is requested, a complete analysis cycle is done for each load combination. In each cycle, the basic stiffness terms of plate elements are modified to account for the effect of membrane forces (ref. 1). For stiffener elements, the basic stiffness matrix is modified to account for the effect of axial forces (ref. 2)

- C. Compute envelopes for the displacements produced by all service load combinations.
- D. For each plate and stiffener element, compute the area of steel required for resisting all ultimate load combinations. For plate elements, the required area of steel is calculated at the element center. For stiffener elements, the area of steel is calculated at each of the element ends. Then, the maximum value of area of steel is reported.

Element Design Forces

Plate Elements

For each ultimate load combination, the program obtains values for in-plane design forces by including the effects of in-plane shear forces as follows:

- Maximum in-plane design forces

$$N_x = N_{xx} + |N_{xy}|$$

$$N_y = N_{yy} + |N_{xy}|$$

$$\text{Maximum } N_{ux} = \begin{cases} N_x & \text{if } N_y \geq 0 \\ N_{xx} + \frac{|N_{xy}^2|}{N_{yy}} & \text{if } N_y < 0 \end{cases}$$

$$\text{Maximum } N_{uy} = \begin{cases} N_y & \text{if } N_x \geq 0 \\ N_{yy} + \frac{|N_{xy}^2|}{N_{xx}} & \text{if } N_x < 0 \end{cases}$$

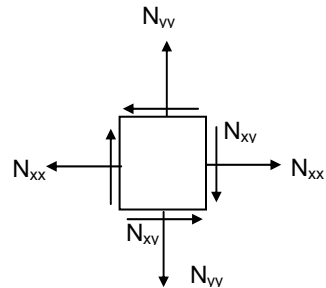

- Minimum in-plane design forces

$$N_x = N_{xx} - |N_{xy}|$$

$$N_y = N_{yy} - |N_{xy}|$$

$$\text{Minimum } N_{ux} = \begin{cases} N_x & \text{if } N_y \leq 0 \\ N_{xx} - \frac{N_{xy}^2}{N_{yy}} & \text{if } N_y > 0 \end{cases}$$

$$\text{Minimum } N_{uy} = \begin{cases} N_y & \text{if } N_x \leq 0 \\ N_{yy} - \frac{N_{xy}^2}{N_{xx}} & \text{if } N_x > 0 \end{cases}$$

In the above equations, N_{xx} , N_{yy} and N_{xy} correspond to the element internal in-plane forces at the element center. The program obtains the values for design bending moments by including the effects of the torsional moment as follows:

- Maximum design bending moments

$$M_x = M_{xx} + |M_{xy}|$$

$$M_y = M_{yy} + |M_{xy}|$$

$$\text{Maximum } M_{ux} = \begin{cases} M_x & \text{if } M_y \geq 0 \\ M_{xx} + \frac{M_{xy}^2}{M_{yy}} & \text{if } M_y < 0 \end{cases}$$

$$\text{Maximum } M_{uy} = \begin{cases} M_y & \text{if } M_x \geq 0 \\ M_{yy} + \frac{M_{xy}^2}{M_{xx}} & \text{if } M_x < 0 \end{cases}$$

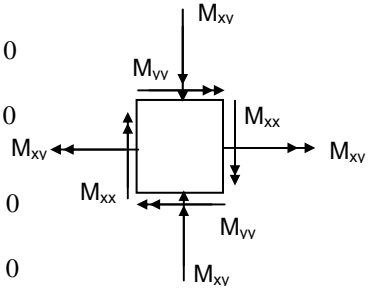

- Minimum design bending moments

$$M_x = M_{xx} - |M_{xy}|$$

$$M_y = M_{yy} - |M_{xy}|$$

$$\text{Minimum } M_{ux} = \begin{cases} M_x & \text{if } M_y \leq 0 \\ M_{xx} - \frac{M_{xy}^2}{M_{yy}} & \text{if } M_y > 0 \end{cases}$$

$$\text{Minimum } M_{uy} = \begin{cases} M_y & \text{if } M_x \leq 0 \\ M_{yy} - \frac{M_{xy}^2}{M_{xx}} & \text{if } M_x > 0 \end{cases}$$

In the above equations, M_{xx} and M_{yy} correspond to the element internal bending moments at the element center, while M_{xy} corresponds to the element internal torsional moment at the element center.

Stiffener Elements

The stiffener element design forces P_u , V_{uy} , V_{uz} , M_{uy} , M_{uz} , and T_u are obtained directly from the element end forces F_x , F_y , F_z , M_x , M_y , and M_z (figure 2-11) using the following relationship:

$$\begin{Bmatrix} N_x \\ V_y \\ V_z \\ T_x \\ BM_y \\ BM_z \end{Bmatrix}_i = \begin{Bmatrix} -F_x \\ F_y \\ F_z \\ M_x \\ M_y \\ -M_z \end{Bmatrix}_i \text{ at node } i \text{ and } \begin{Bmatrix} N_x \\ V_y \\ V_z \\ T_x \\ BM_y \\ BM_z \end{Bmatrix}_j = \begin{Bmatrix} F_x \\ -F_y \\ -F_z \\ -M_x \\ -M_y \\ M_z \end{Bmatrix}_j \text{ at node } j.$$

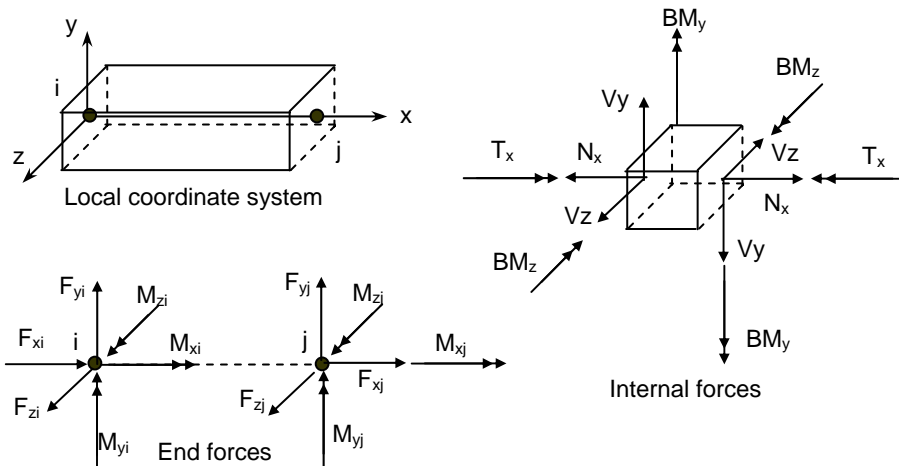

Fig. 2-11. The Stiffener Internal Forces

Required Reinforcement

The required areas of reinforcing steel for flexural and shear are computed based on assumptions conforming to the strength design method.

Flexural design

Flexural design is performed based on the code provisions of ACI318-02 and CSA23.3-94 (see Appendix A).

The required area of steel is calculated by trail and error. The program will try to find the least amount of A_s , between the minimum and maximum values specified by the user, which satisfies the strength requirements of all ultimate load combinations. If a value for A_s cannot be found, the program reports design failure.

For plate elements, it is required to calculate the area of steel in the X and in the Y directions. In the X-direction, the area of steel A_{sx} should be enough to satisfy the strength requirements under the following sets of extreme design forces for each ultimate load combinations:

- Maximum N_{ux} and Maximum M_{ux}
- Maximum N_{ux} and Minimum M_{ux}
- Minimum N_{ux} and Maximum M_{ux}
- Minimum N_{ux} and Minimum M_{ux}

In the Y-direction, the amount of steel A_{sy} should be enough to resist the following sets of extreme design forces for each ultimate load combinations:

- Maximum N_{uy} and Maximum M_{uy}
- Maximum N_{uy} and Minimum M_{uy}
- Minimum N_{uy} and Maximum M_{uy}
- Minimum N_{uy} and Minimum M_{uy}

For stiffener element, the area of steel A_s is calculated such that the strength requirements at both end nodes are satisfied for all ultimate load combinations. The design of stiffener element has two modes: biaxial and uniaxial modes.

The biaxial mode is applied when the flange width is equal to zero (Figure 2.12). In this case, the area of steel is calculated due to P_u , M_{uy} , and M_{uz} . When the flange width is specified, the neutral axis is forced to be along the local y axis. In this case, the area of steel is calculated due to P_u and M_{uy} .

Shear design of stiffener elements

Shear design is performed based on the code provisions of ACI318-02 and CSA23.3-94’s simplified method (see Appendix A).

For stiffener element, web reinforcement for shear and torsion ($\frac{A_v}{s}$) and longitudinal torsion reinforcement (A_l) are calculated such that the strength requirements at both end nodes are satisfied for all ultimate load combinations. The design of stiffener element has two modes: biaxial and uniaxial modes.

The biaxial mode is applied when the flange width is equal to zero. In this case, the amount of web reinforcement ($\frac{A_v}{s}$) is calculated in the Y-direction and in the Z-direction separately.

The maximum values of $\left(\frac{A_v}{s}\right)_y$ and $\left(\frac{A_v}{s}\right)_z$ are reported.

When the flange width is specified, the neutral axis is forced to be along the local y axis. In this case, the amount of web reinforcement ($\frac{A_v}{s}$) is calculated in the Z-

direction only and the maximum value of $\left(\frac{A_v}{s}\right)_z$ is reported. The effective flange

width considered for the design due to torsion is calculated according to clause 13.2.4 for ACI318-02 and clause 13.1 for CSA23.3-94.

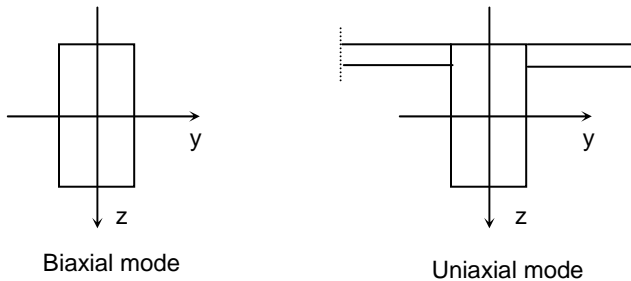

Fig. 2-12. Design Modes for Stiffener elements

Program Results

The program output is organized into tables that may be optionally viewed, printed or sent to file. Furthermore, the tables may be fully or partially output for all or for only selected nodes, members and load combinations.

Nodal Displacements:

Nodal displacements D_x , D_y , and D_z are output for individual service and individual ultimate load combinations. Positive displacement is in the positive direction of the axes.

Reactions:

Restraint and Nodal Spring reactions are output for individual service load and ultimate load combinations for nodes with specified restraints or nodal springs. Nodal translational reactions F_x , F_y , and F_z , and rotational reactions M_x , M_y , and M_z are output. Positive translational reactions are in the direction of the positive axes and positive moment reactions are determined using the right-hand rule.

Element Internal forces:

For each plate element, internal forces N_{xx} , N_{yy} , N_{xy} , M_{xx} , M_{yy} and M_{xy} are output for individual service or ultimate load combination.

For each stiffener element, internal forces N , V_y , V_z , BM_y , BM_z and T_x are output for individual service or ultimate load combination.

Displacement Envelopes:

Maximum nodal displacements D_x , D_y , and D_z from all service load combinations are output. The governing load combination is identified. Positive displacements are in the direction of the positive axes.

Element Reinforcement:

For each plate element, the required areas of reinforcement A_{sx} and A_{sy} are computed based on the average moments per element and are output along with design forces and governing ultimate load combination. If the area of reinforcement in a plate element is greater than one percent, the program indicates that ties may be required. For each stiffener element, the required area of longitudinal reinforcement for flexure and axial loads A_s , shear reinforcement A_v/s , and torsional reinforcement A_t/s and A_l is output along with the design forces and governing ultimate load combination.

References

1. Cook, Robert D., Malkus, David S., and Plesha, Michael E., *Concepts and Applications of Finite Element Analysis*, John Wiley & Sons, Third Edition, 1989.
2. Ghali, A.M. Neville, *Structural Analysis, a Unified Classical and Matrix Approach*, John Wiley & Sons, Second Edition.
3. *ACI 318-95, Building Code Requirements for Structural Concrete*, American Concrete Institute, 1995.
4. *CSA A23.3-94, Design of Concrete Structures*, Canadian standards Association, 1994.

Chapter 3

The *pcaWall* Interface

The *pcaWall* interface is made up of the elements as illustrated below. The content of the interface's *Main Window* changes depending on what you select from any menu displayed on the *Menu Bar* or from any button displayed in the *Tool Bar*. In the illustration below, the *Main Window* is shown contained within a black frame.

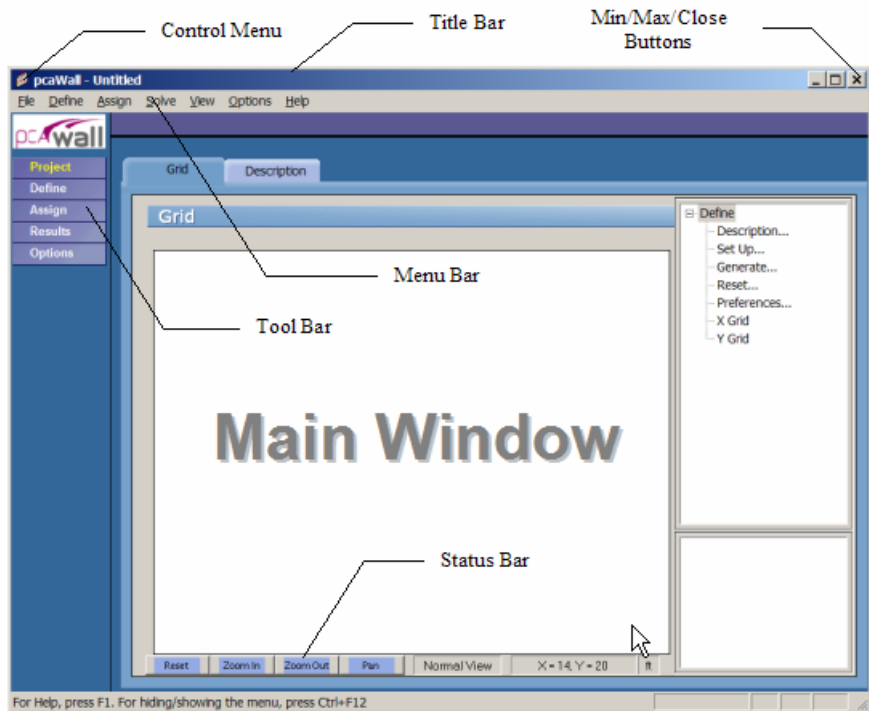

The Main Window is made of 4 distinct areas as illustrated here...

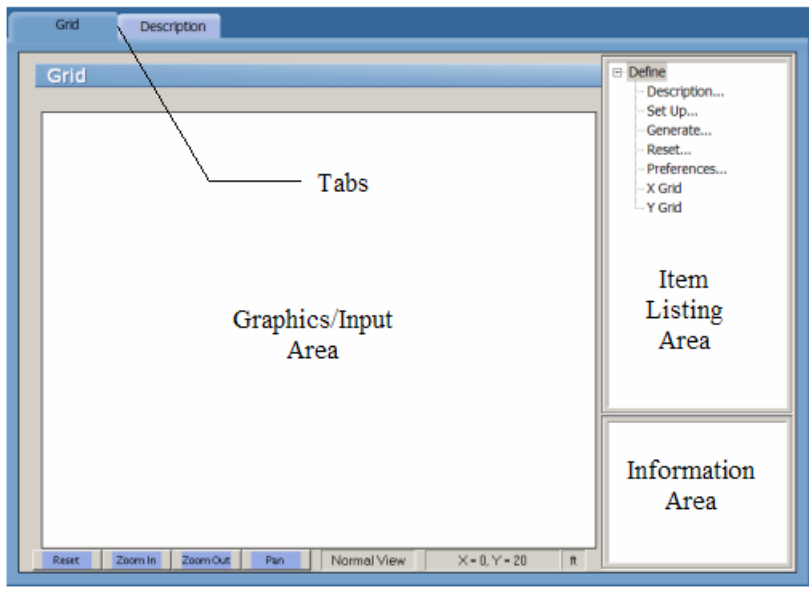

Control-Menu:

The *Control-Menu* is located in the upper-left corner of the screen. It includes commands for restoring, moving, sizing, minimizing, maximizing, and closing the program.

Title Bar:

The *Title Bar* displays the name of the program (pcaWall in this case), along with the path and filename of the current data file in use. If the file is new and has not yet been saved, the word *Untitled* is displayed in the title bar.

Min/Max/Close Buttons:

The *Min/Max/Close* buttons are located in the upper-right corner of the screen. The *Minimize* button (☐) shrinks the program to the Windows Taskbar. The *Maximize* button (☐) enlarges the program so that it covers the entire desktop. After the program has been maximized (takes up the entire screen), the *Maximize* button (☐) is replaced by the *Restore* button (☐). Clicking on the *Restore* button (☐) returns the program to its original size.

Tool Bar:

The *Tool bar* is located on the left side of the screen. There are a total of 5 buttons on the tool bar each one displays various information in the *Main Window* of the program. The *Tool Bar* provides access to commands that are also accessible via the *Menu Bar*. The active tool bar's text will appear in Yellow (highlighted).

Menu Bar:

The *Menu Bar* is located directly beneath the *Title Bar*. There are a total of 7 distinct drop-down menus accessible from the *Menu Bar*. The majority of commands appearing in the drop-down menus are also accessible via the program's *Main Window* area.

Status Bar:

The *Status Bar* is located directly beneath the program's *Main Window* area. It displays important information such as current units, cursor position, and helpful messages.

Tabs (on Main Window):

The *Tabs* are located on the *Main Window* and vary depending on the button you click on the *Tool Bar* or on the command that you select from one of the drop-down menus. Each *Tab* surfaces different GRAPHICS/INPUT AREAS for recording and inputting data as it relates to each project.

Graphics/Input Area (on Main Window):

The *Graphics/Input Area* covers most of the *Main Window*. This is where the graphical editing and data input is done.

Item Listing Area (on Main Window):

The *Item Listing Area* appears on the right side of the *Main Window*. The items appearing in the listing vary depending on the *Tab* that you select. Certain items appearing in listings have “plus” or “minus” signs indicating that the list is expandable or retractable, respectively.

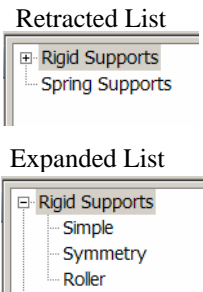

Information Area (on Main Window):

The *Information Area* appears in the lower-right corner of the *Main Window*. This area displays helpful information and values pertinent to the active item that you select in the *Item Listing Area*.

Using the Menus

To access a menu item with your mouse, bring the mouse pointer over the menu and left-click your mouse to have menu items appear within a drop-down menu. Then point to the menu item you wish to access and left-click your mouse again.

To access a menu item with your keyboard, simultaneously press the ALT key and the underlined letter of the menu containing the item you wish to access. Once the drop-down menu appears, you can either repeat the above step for the specific menu item, or use the up/down arrows on your keyboard, select the specific menu item, and press ENTER. For example, to access the Save menu item under the File menu, press ALT+F and then either press ALT+S or use the up/down arrows on your keyboard to select **S**ave before pressing ENTER.

Menu Conventions

The following menu conventions are used in pcaWall.

Menu Convention	Meaning
Dimmed (grayed out) command.	The command is currently unavailable.
An ellipse (...) following a command.	When the command is selected, a dialog box will appear requesting data input or listing options to select from.
A check mark (✓) next to a command.	The command is in effect. When the check mark is removed (by selecting the command), the command is no longer in effect.

Using a Dialog Box

A dialog box is displayed to request information or to supply you with information. A dialog box is usually displayed after you click on a button or request the program to do something specific such as “open” a data file. For

example if you choose the **Open** command from the File menu, the OPEN dialog box will appear to float on top of the program as illustrated here...

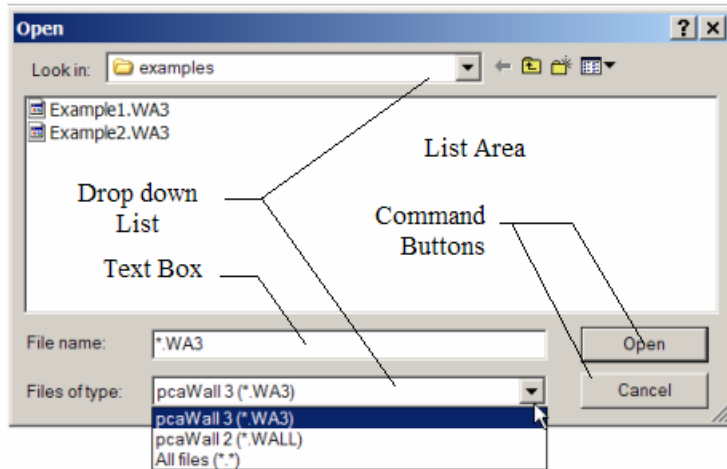

There are several options within various dialog boxes. The illustration above shows only a few.

Other options include “Radio Buttons” and “Check Boxes” as illustrated here...

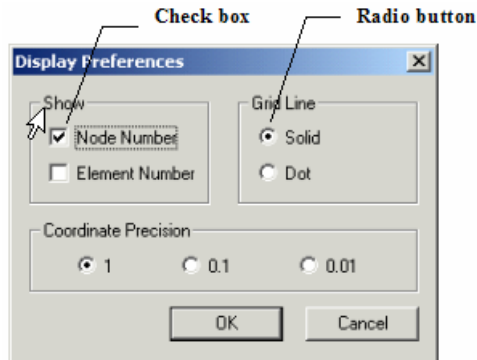

To move from option to option within a dialog box using only your keyboard, press TAB and then use the arrow keys on your keyboard to select. To move backwards, press SHIFT+TAB.

Using the Tool Bar

The Tool Bar located on the left side of the screen provides a fast and easy way to access commands or options without having to use the drop-down menus. The effect of clicking on any of the five buttons contained in the tool bar will be shown in the MAIN WINDOW.

The PROJECT button provides access to the following two tabs...

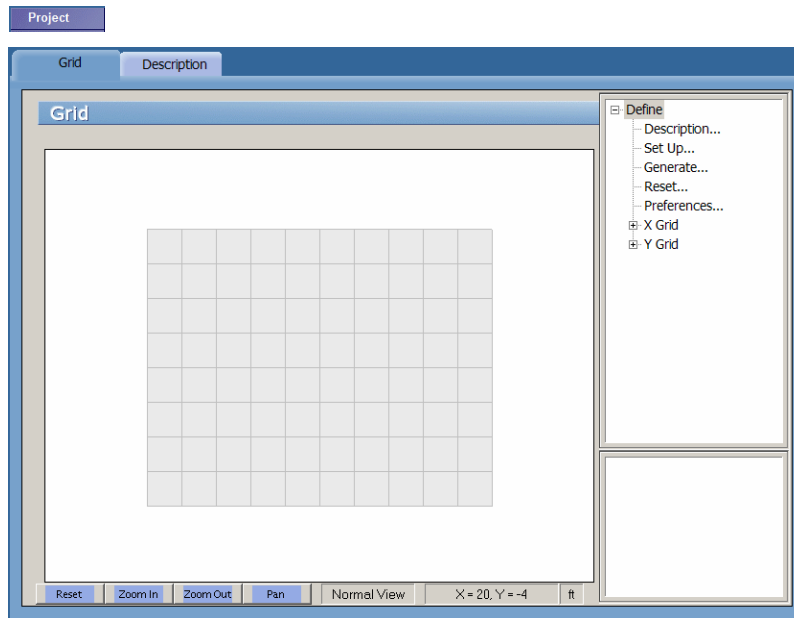

The ITEM LISTING AREA will provide further access to other commands or options.

The available commands and options will change depending on the tab that you click.

The remaining buttons and their respective relations are shown below...

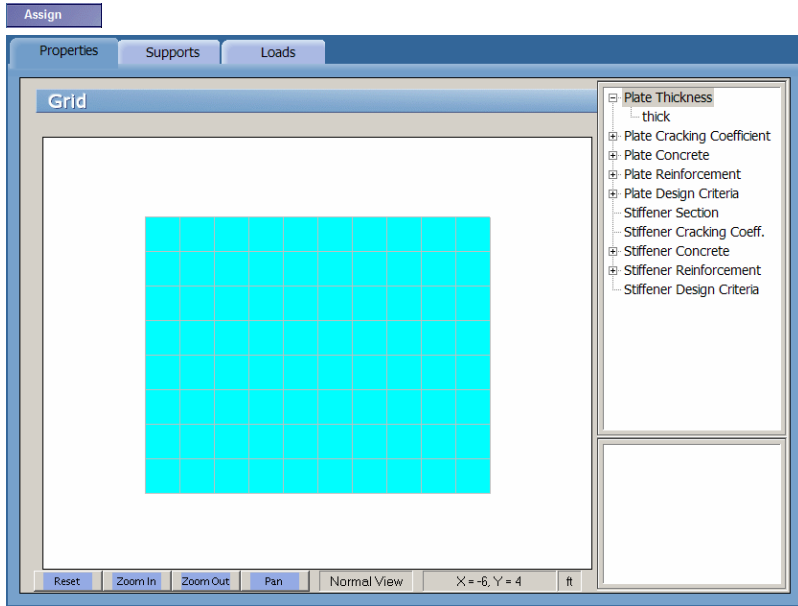
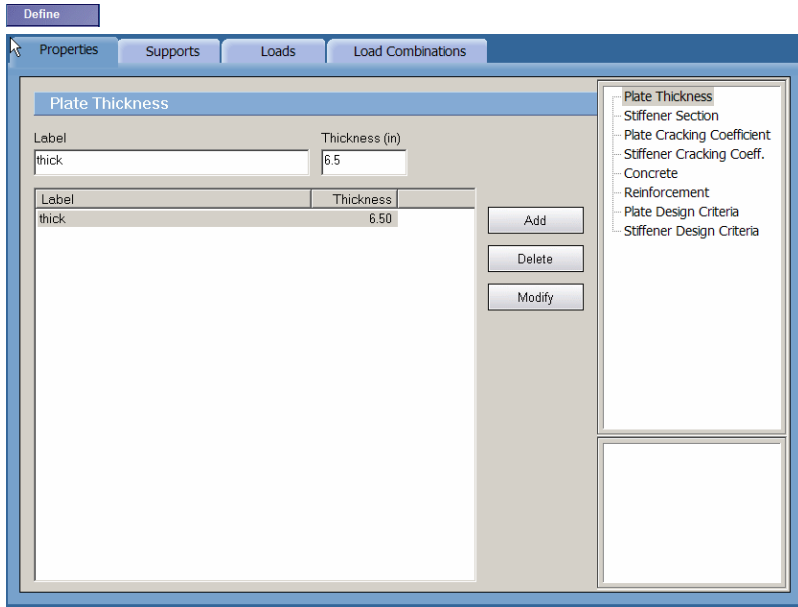

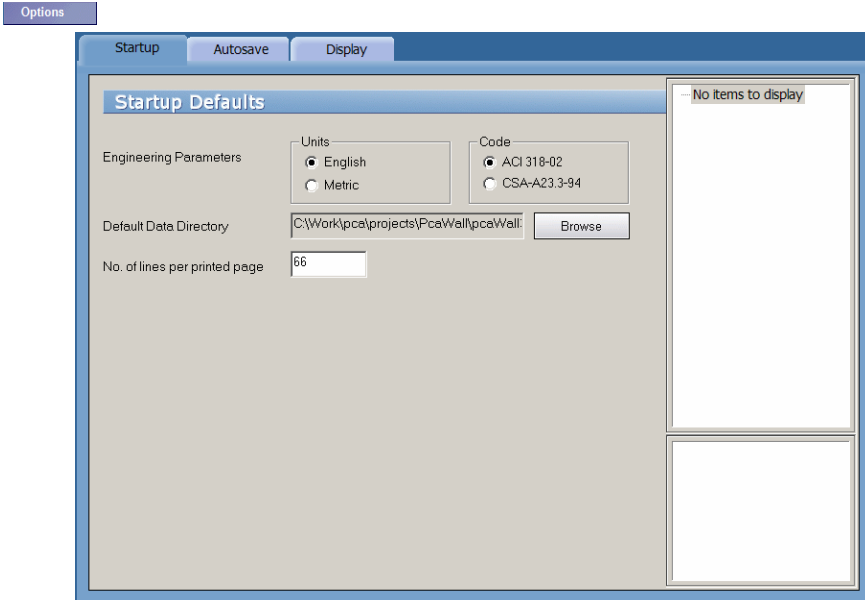
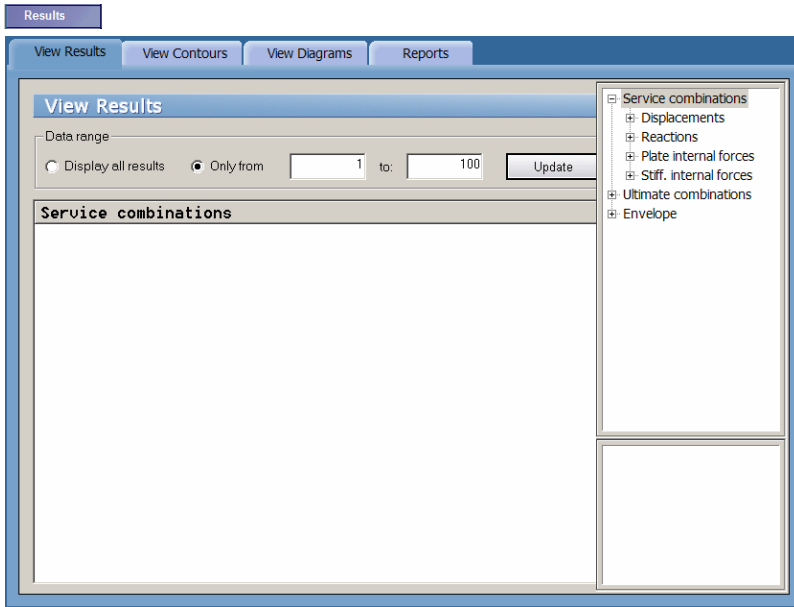

Working with a List Box

A List Box displays a list of choices. If there are more choices than can fit in the box, scroll bars will automatically appear either on the right or at the bottom of the list box allowing you to scroll through the list. To select an item from a list box, click the scroll arrows until the item you wish to select appears in the list box and then click on that item. If you are using the keyboard, use the arrow keys to scroll to the item you want.

To select a single item from a list box:

- Using the mouse, click the scroll arrows until the item you want to select appears in the list box. Click the item.
- Using the keyboard, press the UP or DOWN arrow key to scroll to the item you want.

To select multiple sequential items in a list:

- Using the mouse, click and hold down the left-mouse button on the first item you want to select and then drag the cursor to the last item you want to select. Alternatively, click on the first item you want to select, press and hold down the SHIFT key and click on the last item you want to select. Both items and all items in between are selected. To cancel the selections, release the shift key and click any item.

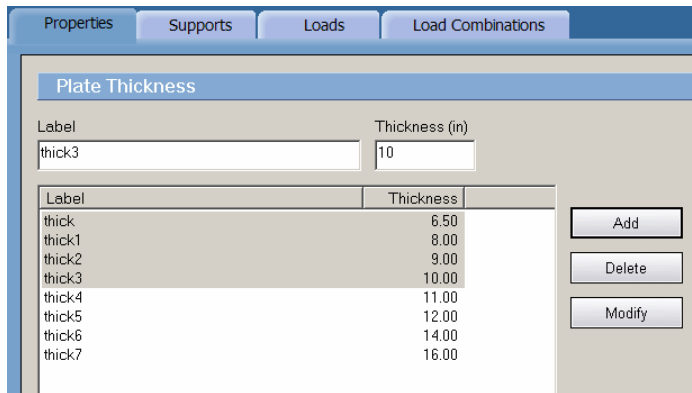

- Using the keyboard, press the UP or DOWN ARROW key to move the cursor to the first item you want to select. Press and hold down the SHIFT key and continue to press the arrow key repeatedly until all the items you want are

selected. To cancel the selections, release the SHIFT key and press one of the arrow keys.

To select multiple non-sequential items in a list:

- Using the mouse, press and hold down the CTRL key and click each item you want to select. To cancel the selection, press and hold down the CTRL key and click the item again

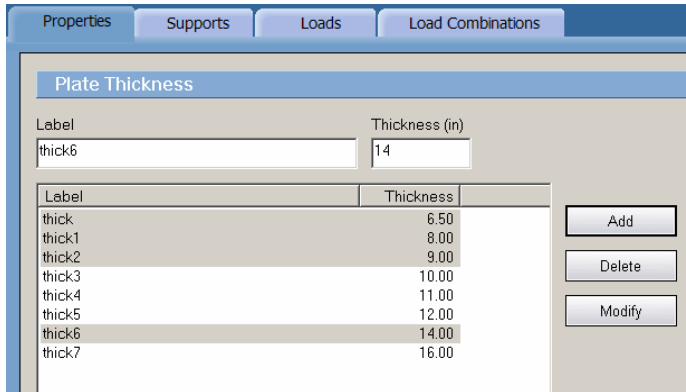

- Using the keyboard, press the UP or DOWN ARROW key to move the cursor to the first item you want to select. Press and hold down the CTRL key and press the SPACEBAR. Continue to press and hold down the CTRL key and use the arrow key until you get to the next item you want to select and then press the spacebar again. Repeat these steps until all items have been selected. To cancel the selections, simply release the CTRL key and press one of the arrow keys.

Working with a Drop-Down List

A Drop-Down list will appear as a rectangular box with the current selection marked and with the following symbol to the right of it...

To see a listing of available choices, click the symbol (arrow) or press DOWN ARROW on your keyboard. Make your selection in the appearing list by either clicking on it with the mouse or by selecting it with the DOWN ARROW on your keyboard.



Working with a Text Box

Text Boxes are where data or information is typed in. When you move into an empty text box, an insertion point (flashing vertical bar) appears. The text you type starts at the *insertion point*. If the box already contains text and you wish to overwrite it, simply select the text, delete it, and then type in the new text.

Using a Command Button

The Command Button (or PUSH BUTTON) is labeled to do exactly what it says. The OPEN, OK and CANCEL buttons are common command buttons. A command button followed by an ellipsis (...) opens another dialog box. The currently selected button has a darker border than other buttons displayed on the dialog box. The button may either be clicked on with the mouse or you may select it and press ENTER on your keyboard.



Using a Radio Button

The Radio Button is one of a group of related options in which you can select only one. When an option is selected, the selected option button will display a black dot. To select an option with the mouse, simply click the mouse button on the respective option. With the keyboard, press TAB to move to the group of options that contains the entry you want and then use the arrow keys to select the respective option.

Using a Check Box

The Check Box is an option that can be turned on or off. Unlike Radio Buttons, you can turn on as many check boxes as you like within one dialog box, even if they are all within a group. When a check box is turned on, and appears in the box. If you are using a mouse, click a blank check box to select it or click a selected check box to clear it. If you are using a keyboard, press TAB to move to the checkbox and then press the SPACEBAR to either select or unselect the box.

File Menu

The **File** menu gives access to file operations, printing operations and to exiting the pcaWall program.

New

Clears any input data and returns the data to the default values so that a new data file may be input.

Open

Opens an existing data file.

Save

Saves the changes made to the current data file to disk.

Save As

Enables you to name or rename a data file.

Revert

Discards any changes to the data file and returns to the most recently saved version of the data file. This option will only be available if the data file has been previously saved and there have been modifications done on the data file since. Do not save the data file immediately prior to reverting otherwise this command will have no effect.

Print Results

Provides a printout of the input and output data.

Print Screen

Prints the graphical image displayed in the GRAPHICS/INPUT AREA of the MAIN WINDOW.

Exit

Ends the pcaWall program.

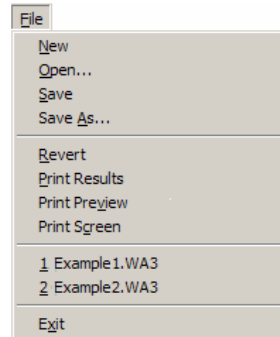

Define Menu

The **Define** menu provides access to commands used to define all of the input data. The information you input via the commands found under the Define menu will be used when assigning, and for calculating and designing the slab.

Project Description

Defines and records the particulars on the project including project name and description, project date and time, and engineering parameters including units of measure and design code.

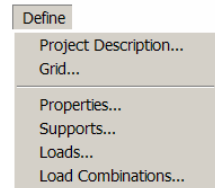

Grid

Defines the grid lines that make up the rectangular grid system. The slab model is defined based on the grid system specified here. This command also gives access to the grid preferences where you are able to show/hide node and element numbers, select between dotted or solid grid lines, and specify the coordinate precision.

Properties

- **Plate thickness**
Defines the plate element thickness entries.
- **Stiffener section**
Defines the stiffener element section properties including section type (rectangular, circular), section projection, (to the left, at the middle, to the right), section dimensions and flange dimensions.
- **Plate cracking coefficients**
Defines the cracking coefficients that reduce the plate element stiffness during the finite element analysis.
- **Stiffener cracking coefficients**
Defines the cracking coefficients that reduce the stiffener element stiffness during the finite element analysis.

- Concrete
Defines the concrete material properties including compressive strength, unit weight, Young's modulus and Poisson's ratio.
- Reinforcement
Defines reinforcing steel material properties including yield strength and Young's modulus.
- Plate design criteria
Defines the parameters that set the criteria for designing the plate element. These parameters include minimum reinforcement ratio and reinforcement layout.
- Stiffener design criteria
Defines the parameters that set the criteria for designing the stiffener element. These parameters include minimum reinforcement ratio and reinforcement layout.

Supports

- Rigid supports
Defines rigid support properties including the restraint condition in the direction of each degree of freedom.
- Spring supports
Defines rigid support properties including the value of stiffness in the direction of each degree of freedom.

Loads

- Point loads
Defines point load properties including the value of component in the direction of each degree of freedom as well as the eccentricity away from the wall plane.
- Uniform area loads
Defines uniform area load properties including the value of component in the direction of each translational degree of freedom.

- Linear area loads

Defines linear area load properties including the value of component in the direction of each translational degree of freedom. The load values are defined at two levels of Y-coordinates (Y1 and Y2).

- Uniform line loads

Defines uniform line load properties including the value of component in the direction of each translational degree of freedom as well as the eccentricity away from the wall plane.

Load Combinations

Defines load combinations for both service and ultimate levels under which the model is to be analyzed and designed.

Assign Menu

The Assign menu provides access to commands used to input the model geometry and assign the defined properties and loads to the nodes and elements. All assignments are done graphically.

Properties

- Plate thickness

Assign the various plate thickness definitions in order to grid spaces to define plate elements.

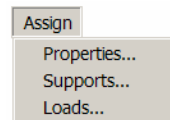

- Plate cracking coefficients

Assign the various cracking coefficient definitions to plate elements.

- Plate concrete

Assign the various concrete definitions to plate elements.

- Plate reinforcement

Assign the various reinforcement definitions to plate elements..

- Plate design criteria

Assign the various plate design criteria definitions to plate elements.

- Stiffener section
Assign the various stiffener section definitions in order to grid to define stiffener elements.
- Stiffener cracking coefficients
Assign the various cracking coefficient definitions to stiffener elements.
- Stiffener concrete
Assign the various concrete definitions to stiffener elements.
- Stiffener reinforcement
Assign the various reinforcement definitions to stiffener elements.
- Stiffener design criteria
Assign the various stiffener design criteria definitions to stiffener elements.

Supports

Assigns the various rigid and spring support definitions to nodes.

Loads

- Point loads
Assigns the various point load definitions to nodes.
- Uniform area loads
Assigns the various Uniform area definitions to plate elements..
- Linear area loads
Assigns the various linear area load definitions to plate elements..
- Uniform line loads
Assigns the various uniform line load definitions to stiffener elements or to the edges of plate elements

Solve Menu

The Solve menu provides access to commands used to execute the analysis and design.

Run Analysis & Design

Invokes the finite element solver and then invokes the concrete design module.

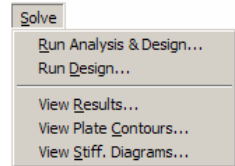

Run Design

Invokes the concrete design module.

View Results

Provide access to the analysis and design results in tabular forms.

View Contours

Provides access to graphical representations of the results referring to plate elements.

View Diagram

Provides access to graphical representations of the results referring to stiffener elements.

View Menu

The View menu provides access to commands used to manipulate the Graphical display and to control what is to be displayed in the GRAPHICS AREA.

Status Bar

Toggles the Status Bar at the bottom of the screen on or off.

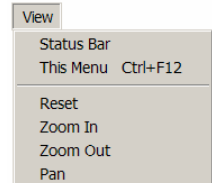

This Menu (Ctrl+F12)

Toggles the Menu Bar at the top of the screen on or off.

Reset

Resets the graphical window to the default view. Zooming and Translating while Assigning

Zoom-in

Sets the graphical window in the zoom-in mode.

Zoom-out

Sets the graphical window in the zoom-out mode.

Pan

Sets the graphical window in the pan mode.

Options Menu

The Options menu provides access to commands used to save certain settings as defaults for subsequent new projects.

Startup defaults

Provides access to saving defaults such as units of measurement and design code so that the system knows to use these for any future data file creations.

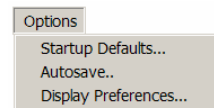

Autosave

Provides access to specify that the system automatically save data periodically without you having to necessarily select the **File/Save** command.

Display preferences

Provides access to turning on and off the display of node and element numbers, setting the grid line width, and specifying the precision of coordinates displayed in the graphics window.

Help Menu

The Help menu provides access to electronic support resources and to information on the pcaWall version.

Help Topics

Provides access to all available help topics. Click on any topic and a help screen will appear with information about that item.

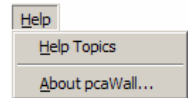

About pcaWall

Displays a message box displaying copyright information and the version number of pcaWall.

Chapter 4

Operating *pcaWall*

In this chapter, the sections follow the order in which commands and options appear under the subsequent menu items.

We begin with those found under the **File** menu and end with those under the **Help** menu.

Many of the commands and options that appear under these menus are alternatively accessible by other methods, too. Consequently, these other methods are also explained.

Creating a New Data File

When *pcaWall* is first loaded, the program is ready to begin receiving input for a new project. Unless you save the file, the data will not have a filename associated with it, and the title bar will display the word *Untitled* as illustrated here...

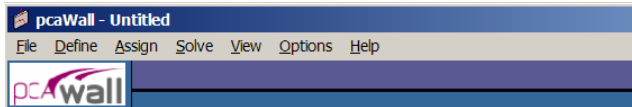

- From the **File** menu, choose **New**. This clears the screen in preparation for a new project or data entry file and returns the program to its default settings.
- If existing data on an open project has been changed prior to executing the **New** command, the program will display the following message box inquiring whether you wish to save the data on the open project or data file before creating a new file...

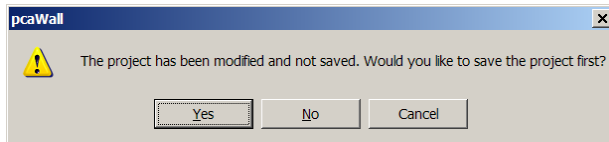

Opening an Existing Data File

From the **File** menu, choose **Open** to have the program display the following dialog box...

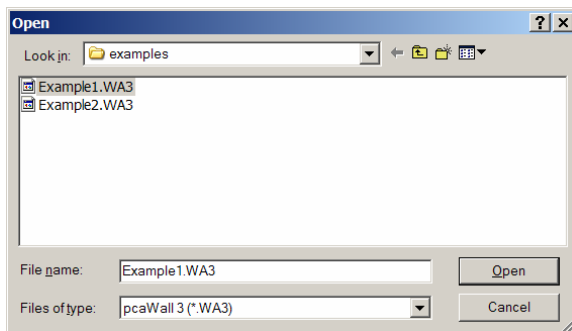

All files with WA3 extensions contained in the current drive and directory are displayed in the listing.

To open a WA3 file that exists in another drive or directory, use the LOOK IN drop-down list and locate the folder where the file exists. Once you locate the folder, the file will appear in the listing. From the white listing area, either select the file that is to be opened and click on the OPEN button, or simply double-click on the respective file.

You can also open data files with WAL extension that were created by the previous version of the program. Use FILES OF TYPE drop-down list to change the type of data files displayed in the OPEN dialog box and browse to the file you want to open.

Saving the Data

pcaWall files are saved in binary format with WA3 extensions. When information in a data file is modified and until the file is saved, the Title bar will display the word (*Modified*) as illustrated here...

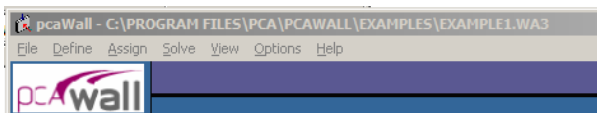

To save your data with the same filename:

- If you are editing an already existing data file and that file has previously been saved (i.e. the TITLE BAR displays a filename), then from the **File** menu, choose the **Save** command. The changes will be recorded under the same filename and the old data file will be overwritten.

To save your data for the first time or to give an existing data file a new filename:

- If you are saving a new data file for the first time (i.e. the TITLE BAR displays *Untitled*), then when you choose **Save** or **Save As** from the **File** menu, the following SAVE AS dialog box will appear...

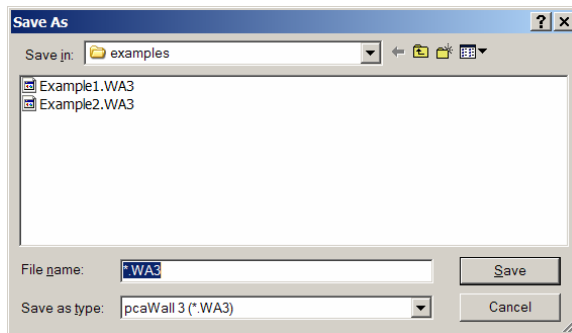

- Similarly, If you are editing an already existing data file and that file has previously been saved (i.e. the TITLE BAR displays a filename), and you wish to record the changes under a different filename, then choose **Save As** to have the program surface the SAVE AS dialog box.
- Use the SAVE IN drop-down list and locate the folder where the file is to be saved. Once you locate the folder, the white listing area will display any other pcaWall files that have been saved in that folder. Double-click in the FILE NAME text box and type a filename. (You need not enter an extension since, by default, the program will affix the WA3 extension to the filename.) Choose the SAVE button to finish recording the data file.

Reverting to the Last Saved Data File

- If you have begun to make changes to a data file that has previously been saved, (i.e. the TITLE BAR displays a filename), and you suddenly wish to discard all the changes and revert back to the previously saved data file, then from the File menu, select Revert.

- The program will verify your intention with the following message box...
- Click on Yes only if you are certain that you wish to discard all changes since the last time the file was saved. If you are not sure, another option would be to actually save the file under a different name, and then re-open the old data file.

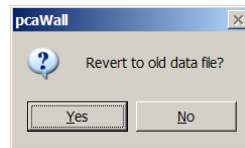

Note: If **Autosave** option is enabled the program will revert to the data previously saved by the **Autosave** function.

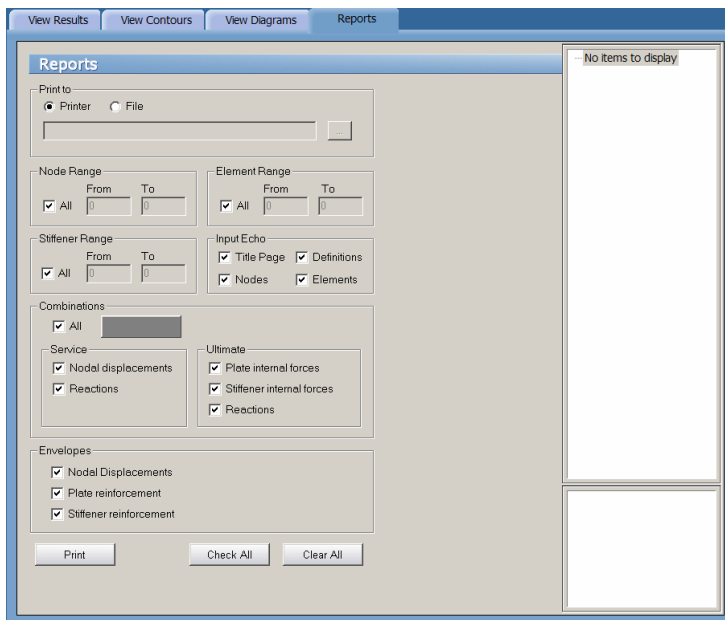

Printing Results

- From the **File** menu, choose **Print Results** to have the program surface the REPORTS folder as illustrated here...

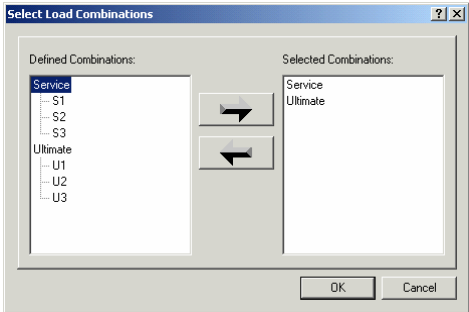

Alternatively, you could have clicked on the **Results** button located on the toolbar, and then on the REPORTS tab.

- Place a checkmark in the TITLE PAGE check box if you wish to include a title page with the printout.

- From the INPUT ECHO group, you may select the tables to be printed...
DEFINITIONS: Will print all the input data entered using the **Define** menu commands.
NODES: Will list all nodal data including coordinates, assignments and loads.
ELEMENTS: Will print all element indexes, assignments and loads.
- Select the RESULTS to be printed. For more information about the output tables, see *Program Results* in Chapter 2.
- In the SERVICE group, select which results to be printed for the selected service load combinations.
- In the ULTIMATE group, select which results to be printed for the selected ultimate load combinations.
- In the NODE RANGE, ELEMENT RANGE and STIFFENER RANGE groups, select the ALL check box for a comprehensive output. For selective printing, specify the range of nodes and and/or elements to print for.
- In the COMBINATIONS group, select ALL to print for all service and ultimate load combinations. To print for specific combinations, choose the SELECT button to have the program surface the following dialog box...
 
- Highlight the combinations from the DEFINED COMBINATIONS list, and click on the  button to move them to the SELECTED COMBINATIONS list. Repeat for all load combinations you wish to select under both SERVICE and ULTIMATE. To remove a selected combination, highlight the combination from the SELECTED COMBINATIONS list and click on the  button. Click on the OK button when done.
- Choose the ENVELOPES that are to be included in the output (printout).
- Alternatively, CHECK ALL button can be used to include all items in the printout. Clicking on the CLEAR ALL button will clear all selected items.

- In the PRINT TO group, specify whether the output should be sent to the default printer or if it should be saved to a file. If FILE is selected, click on the  button to specify what it should be named and where it should be saved.
- Click on the PRINT button.

Printing the Screen

- From the **File** menu, choose **Print Screen** to have the program surface the standard Windows print dialog box similar to the following....
- This command will print the GRAPHICS AREA in a WYSIWYG format. In order for this command to be enabled, a folder that contains a graphical image must be the active folder...

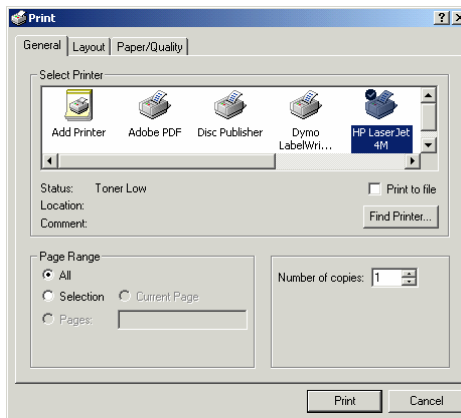

Exiting the Program

From the **File** menu, choose **Exit**. If the data file has been modified since the last time it was saved, i.e. the word (*Modified*) appears in the TITLE BAR, then the program will display the following message box...

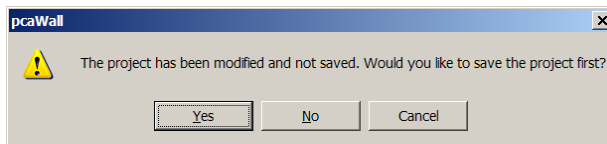

Click on YES to save. NO will exit without saving, and CANCEL will ignore the **Exit** command and return you to the data file.

Defining the Project Description

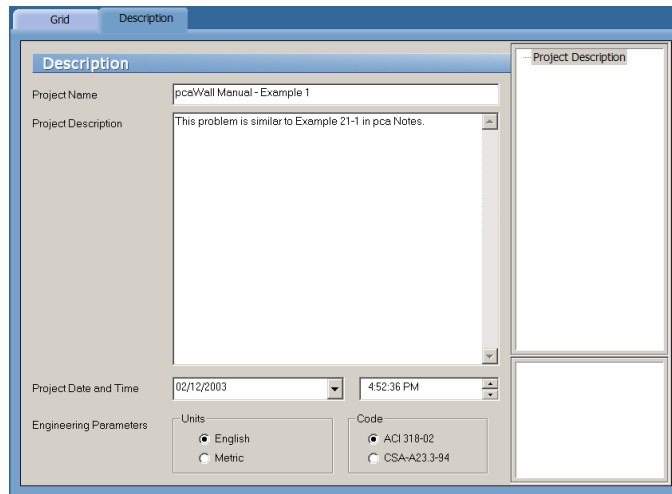

- From the **Define** menu, choose **Project Description** to have the program surface the DESCRIPTION folder as illustrated here...
Alternatively, you could have clicked on the **Project** button located on the toolbar, and then on the DESCRIPTION tab.
- Enter the Project Name and any details/notes describing the project (PROJECT DESCRIPTION). The Project Date And Time will default to the instance you started the project however you are free to change it. These fields help organize and identify data sets.
- From the UNITS options group, choose the applicable units of measure and from the CODE options group, select the appropriate design code.

Defining the Grid

- The rectangular grid system is defined by inputting the coordinates of the X and Y grid lines. Note that it is possible to generate multiple, equally spaced grid lines as well as individual ones at any location.
- From the **Define** menu, choose **Grid** to have the program surface the GRID folder as illustrated here...

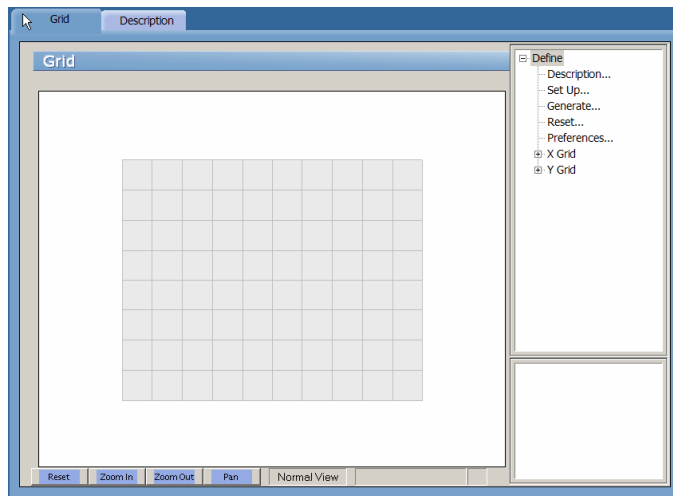

- Alternatively, you could have clicked on the **Project** button located on the toolbar, and then on the GRID tab.
- If you wish, you can enter a name and description for the grid. To do this, double-click on DESCRIPTION... found in the right item listing area. The program will surface the following dialog box...
- Enter a NAME and DESCRIPTION or note and click on OK.

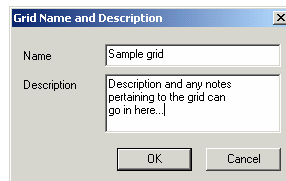

To Enter Grid Lines Individually:

- Double-click on SET UP... found in the right ITEM LISTING AREA to have the program surface the following...
- Select the grid direction from the respective option group, X-Direction or Y-Direction. Grids in the X-Direction are perpendicular to the X-axis and those in the Y-Direction are perpendicular to the Y-axis.
- Enter a grid line coordinate. This value, in feet or meters, represents the orthogonal distance

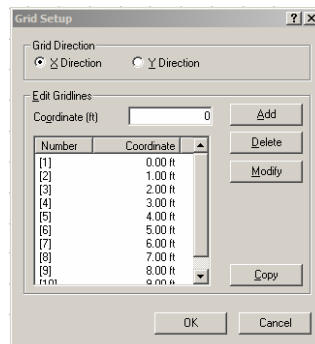

from the origin to the grid line.

- Choose the ADD button to add the grid coordinate to the listing area.
- Repeat the two steps above for each grid line.
- If you wish to enter grids separately and individually in the other direction then repeat the above four steps. If you wish to copy the grid lines, you can input them in one direction and then press the COPY button to mirror them in the other direction. For example, if you just finished defining the grid lines in the X-Direction then the COPY button will copy all X-grid lines to Y-Direction.

To Delete Grid Lines:

- Select the grid line you wish to delete and choose the DELETE button.

To Edit the Position of a Grid Line:

- Select the grid line you wish to edit, change its location by overwriting the value that is displayed in the COORDINATE text box and choose the MODIFY button.

To Generate Grid Lines:

Grid Lines that are spaced at equal intervals may be generated by inputting the coordinate (distance from the origin) of the first grid line, the number of grid lines and the spacing between two consecutive grid lines.

- With the GRID tab surfaced, double-click on GENERATE... found in the right ITEM LISTING AREA to have the program surface the following...
- To generate grids in the X-direction, place a checkmark in the X-Direction checkbox. To generate grids in the Y-Direction, place a checkmark in the Y Direction check box. Recall that grids in the X-Direction are perpendicular to the X-axis and those in the Y-Direction are perpendicular to the Y-axis.
- For each direction, enter the coordinate of the first grid line to be generated, the number of grid lines to be generated (including the first one) and the spacing between two consecutive grid lines.

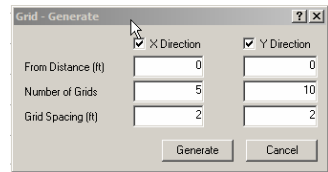

- Click on the GENERATE button to have the program generate the respective grid lines.

To Remove all the Grid Lines:

- Double-click on RESET... found in the right ITEM LISTING AREA to have the program surface the following...
- Note that if you choose to proceed, any material properties, loads, etc. that have already been assigned will have to be re-assigned.
- After confirming your intention, all the grid lines will be removed.

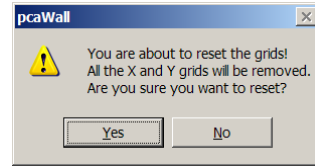

To Choose the Grid View Preferences:

- Double-click on PREFERENCES... found in the right ITEM LISTING AREA to have the program surface the following...
- If you wish for the grid to display the NODE NUMBERS and/or the ELEMENT NUMBERS, place checkmarks in the appropriate box(es).
- Select the style of the grid line, SOLID or DOTTED.
- Specify the COORDINATE PRECISION. This value relates to the precision of the cursor location. (Recall that the location of the cursor is displayed in the STATUS BAR.)
- Click on OK to register your selections/changes.

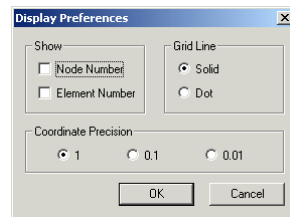

To View the Grid Coordinates:

In the right ITEM LISTING AREA, click on the symbol next to the X GRID or Y GRID item(s) to expand the list of grid coordinates. Notice how the grid that is selected appears in red in the GRAPHICS/INPUT AREA.

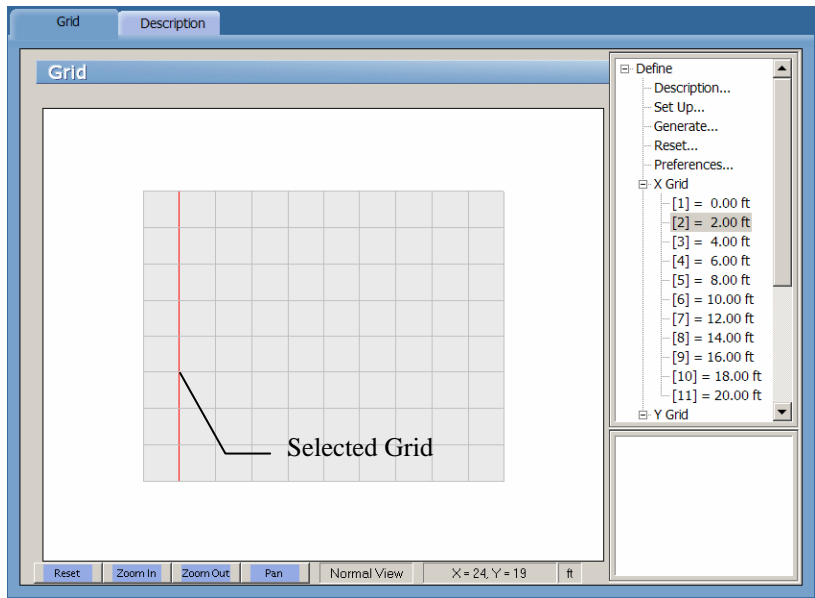

Defining Properties

The following properties can be specified:

- plate element thickness,
- stiffener section properties: section Type, section projection (offset), section dimensions and flange dimensions.
- plate cracking coefficients for the in-plane action and for the out-of-plane (bending) action.
- stiffener cracking coefficients for the cross-section area, the moment of inertia (I_y , I_z) and the torsional constant (J).
- concrete compressive strength (f'_c), Density, Young's modulus (E_c), and Poisson's ratio.
- reinforcement yield strength (f_y), Young's modulus (E_s), minimum/maximum ratios and location.

- From the **Define** menu, choose **Properties** to have the program surface the PROPERTIES folder as illustrated here...

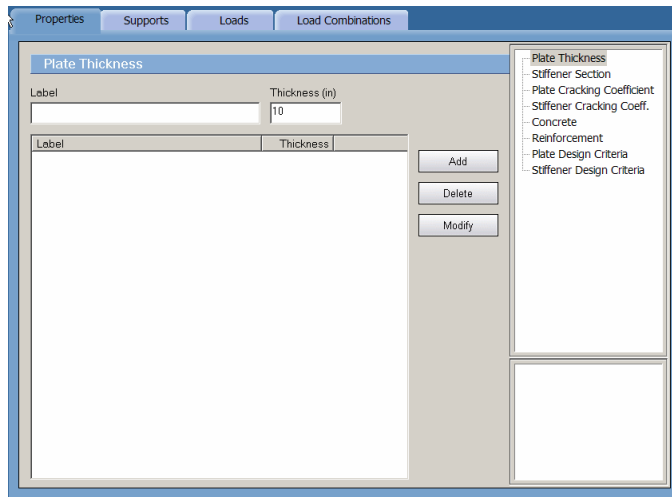

Alternatively, you could have clicked on the **Define** button located on the toolbar, and then on the PROPERTIES tab.

To define plate element thickness:

- Click on PLATE THICKNESS... found in the right ITEM LISTING AREA to have the program surface the Plate Thickness input screen...

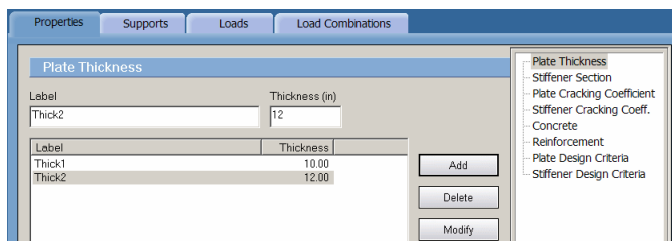

- Enter a label or ID in the LABEL text box.
- Enter the thickness in the THICKNESS text box.
- Click on the ADD button to add the entry to the list box.
- Repeat the steps outlined above for each new entry.

- To edit an entry, select it from the list box, modify its values in the text boxes and click on the MODIFY button to register the changes.
- To delete an entry, select it from the list box and click on the DELETE button.

To define stiffener element section:

- Click on STIFFENER SECTION... found in the right ITEM LISTING AREA to have the program surface the Stiffener Section input screen...

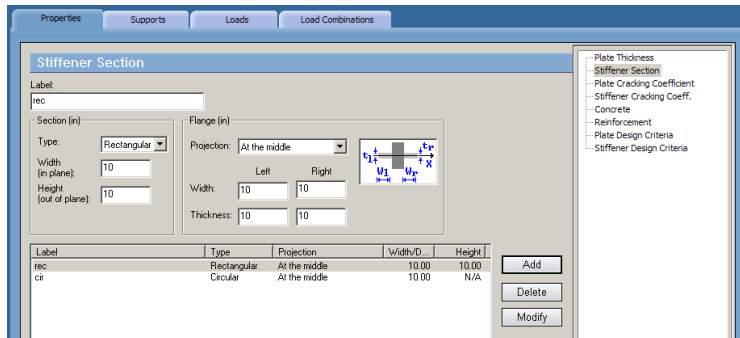

- Enter a label or ID in the LABEL text box.
- Select the corresponding section type from the TYPE combo box
- For rectangular section, enter the width and the height in the WIDTH and the HEIGHT text boxes respectively. Width is measured in the direction of the wall plane while the height is measured normal to the wall plane. For circular section enter the Diameter in the WIDTH text box.
- Select the section projection from the PROJECTION combo box. The projection determines the position of the flange along the height of the section. For rectangular sections, there are 3 choices: *to the left*, *to the right* and *at the middle*. For circular sections, *at the middle* is the only option.
- Enter the flange width and thickness for the left and the right flanges. The entered dimensions are used to calculate section stiffness during the finite element analysis as well as for flexural design. For design due torsion, flange dimensions are reduced as explained in chapter 2.
- Click on the ADD button to add the entry to the list box.

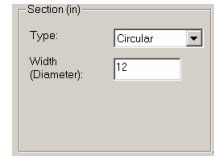

- Repeat the steps outlined above for each new entry.
- To edit an entry, select it from the list box, modify its values in the text boxes and click on the MODIFY button to register the changes.
- To delete an entry, select it from the list box and click on the DELETE button.

To define plate cracking coefficients:

- Click on PLATE CRACKING COEFFICIENTS... found in the right ITEM LISTING AREA to have the program surface the Plate Cracking Coefficients input screen...

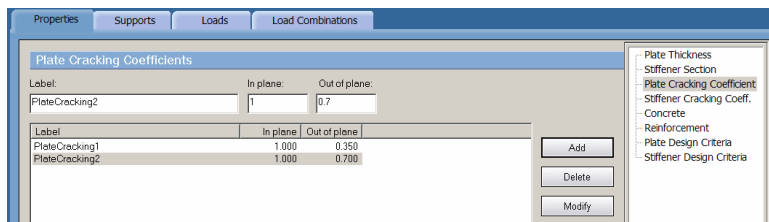

- Enter a label or ID in the LABEL text box.
- Enter the in-plane and out-of-plane coefficients in the respective text boxes. Cracking coefficients reduce the plate element stiffness used in the finite element analysis in order to account for the concrete section cracking.
- Click on the ADD button to add the entry to the list box.
- Repeat the steps outlined above for each new entry.
- To edit an entry, select it from the list box, modify its values in the text boxes and click on the MODIFY button to register the changes.
- To delete an entry, select it from the list box and click on the DELETE button.

To define stiffener cracking coefficients:

- Click on STIFFENER CRACKING COEFFICIENTS... found in the right ITEM LISTING AREA to have the program surface the Stiffener Cracking Coefficients input screen...

Properties Supports Loads Load Combinations

Stiffener Cracking Coefficients

Label: StiffCracking2

Cracking coefficients

Area: 1 Inertia (I_y): 0.7 Inertia (I_z): 0.7 Torsion (J): 0.1

Label	Area	Inertia (I _y)	Inertia (I _z)	Torsion (J)
StiffCracking1	1.000	0.350	0.350	0.100
StiffCracking2	1.000	0.700	0.700	0.100

Add Delete Modify

- Plate Thickness
- Stiffener Section
- Plate Cracking Coefficient
- Stiffener Cracking Coeff.
- Concrete
- Reinforcement
- Plate Design Criteria
- Stiffener Design Criteria

- Enter a label or ID in the LABEL text box.
- Enter the coefficients for the Area, I_y , I_z and J in the respective text boxes. Cracking coefficients reduce the stiffener element stiffness used in the finite element analysis in order to account for the concrete section cracking.
- Click on the ADD button to add the entry to the list box.
- Repeat the steps outlined above for each new entry.
- To edit an entry, select it from the list box, modify its values in the text boxes and click on the MODIFY button to register the changes.
- To delete an entry, select it from the list box and click on the DELETE button.

To define concrete properties:

- Click on CONCRETE... found in the right ITEM LISTING AREA to have the program surface the Concrete input screen...

Properties Supports Loads Load Combinations

Concrete

Label: conc2

Density (pcf): 145 f'c (ksi): 3 Ec (ksi): 3155.92 P. Ratio: 0.2

Label	Density	f _c	E _c	P. Ratio
conc1	145.00	4.00	3644.15	0.20
conc2	145.00	3.00	3155.92	0.20

Add Delete Modify

- Plate Thickness
- Stiffener Section
- Plate Cracking Coefficient
- Stiffener Cracking Coeff.
- Concrete
- Reinforcement
- Plate Design Criteria
- Stiffener Design Criteria

- Enter a label or ID in the LABEL text box.
- Enter the Compressive Strength (f'_c) and Density in the respective text boxes.
- The Young's Modulus of elasticity (E_c) is calculated automatically and will display a result that is respective of the equations in the selected Code. Note that the value of E_c can be modified if it differs from the calculated value.

- Enter the Poisson's Ratio for the concrete
- Click on the ADD button to add the entry to the list box.
- Repeat the steps outlined above for each new entry.
- To edit an entry, select it from the list box, modify its values in the text boxes and click on the MODIFY button to register the changes.
- To delete an entry, select it from the list box and click on the DELETE button.

To define reinforcing steel properties:

- Click on REINFORCEMENT... found in the right ITEM LISTING AREA to have the program surface the Reinforcement input screen...

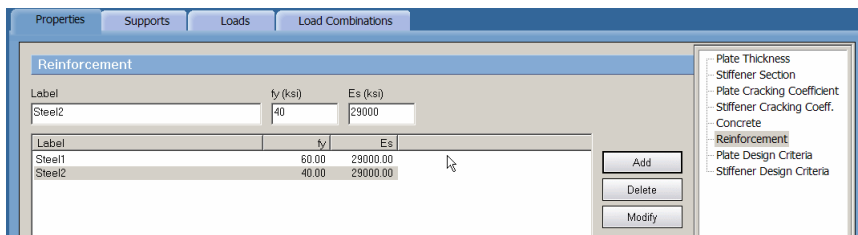

Label	f_y (ksi)	E_s (ksi)
Steel1	60.00	29000.00
Steel2	40.00	29000.00

- Enter a label or ID in the LABEL text box.
- Enter the Yield Strength (f_y) and the Young's Modulus of elasticity (E_s) for the steel.
- Click on the ADD button to add the entry to the list box.
- Repeat the above steps for each reinforcement entry.
- To edit an entry, select it from the list box, modify its values in the text boxes and click on the MODIFY button to register the changes.
- To delete an material entry, select it from the list box and click on the DELETE button.

To define plate design criteria:

- Click on PLATE DESIGN CRITERIA... found in the right ITEM LISTING AREA to have the program surface the Plate Design Criteria input screen.
- Enter a label or ID in the LABEL text box

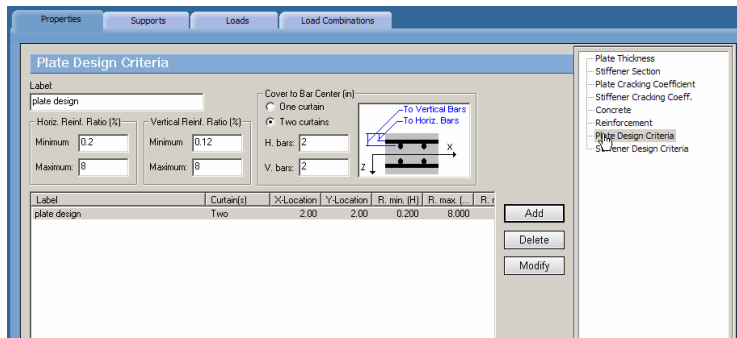

- Select the Number of reinforcement layers. If TWO CURTAINS is selected, reinforcement layout is considered symmetrical about the wall mid plane.
- Specify the bar cover for the bars running in the X and Y directions. The cover is measured from the left side of the wall to the centroid of the bar.
- Enter the minimum and maximum ratios for reinforcement running in the X and Y directions.
- Click on the ADD button to add the entry to the list box.
- Repeat the above steps for each new entry.
- To edit an entry, select it from the list box, modify its values in the text boxes and click on the MODIFY button to register the changes.
- To delete an entry, select it from the list box and click on the DELETE button.

To define stiffener design criteria:

- Click on STIFFENER DESIGN CRITERIA... found in the right ITEM LISTING AREA to have the program surface the Stiffener Design Criteria input screen.
- Enter a label or ID in the LABEL text box

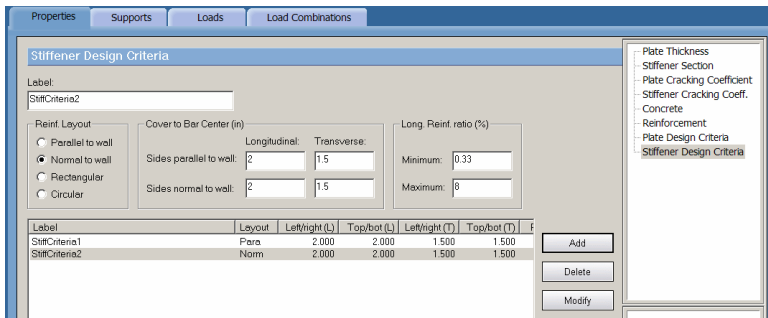

- Select the *Reinforcement Layout*. The various options are illustrated below.

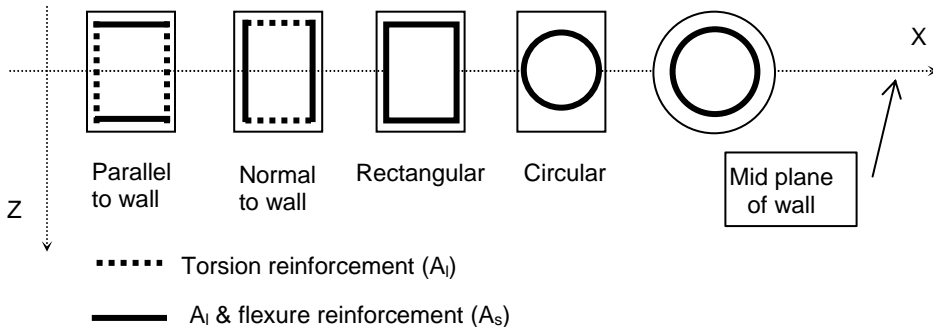

The abovementioned options are for the part of longitudinal reinforcement that resists flexure and axial loads. The part of longitudinal reinforcement that resists torsion is either rectangular or circular depending on the selected layout.

Also, it should be mentioned that for stiffener elements that have circular sections, circular layout is the only option that can be applied to those elements.

- Enter the cover to longitudinal and transverse reinforcements. Cover is measured from the section side to the centroid of bar.
- Enter the minimum and maximum ratios for longitudinal reinforcement. These ratios are used to check flexural design only. When torsional longitudinal reinforcement is required the total ratio of steel may exceed the maximum value specified here.

- Click on the ADD button to add the entry to the list box.
- Repeat the above steps for each new entry.
- To edit an entry, select it from the list box, modify its values in the text boxes and click on the MODIFY button to register the changes.
- To delete an entry, select it from the list box and click on the DELETE button.

Defining Supports

From the **Define** menu, choose **Supports** to have the program surface the SUPPORTS folder as illustrated here...

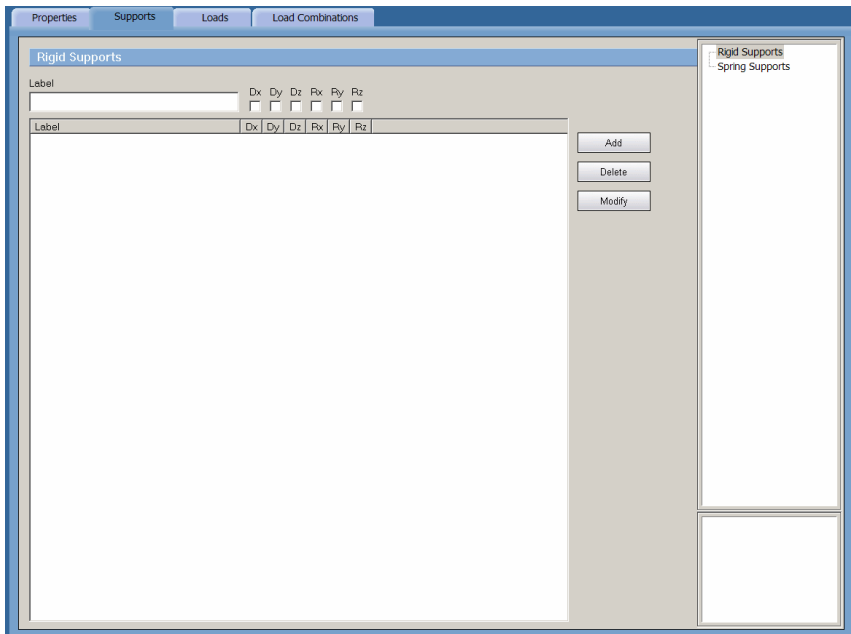

Alternatively, you could have clicked on the **Define** button located on the toolbar, and then click on the SUPPORTS tab.

To define rigid supports:

- Click on RIGID SUPPORTS... found in the right ITEM LISTING AREA to have the program surface the Rigid Supports input screen.

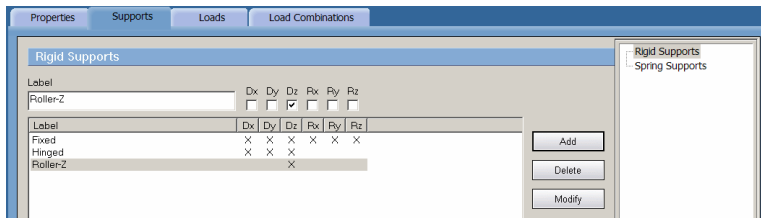

- Enter a label or ID in the LABEL text box.
- Check the degrees of freedom that are required to be restrained.
- Click on the ADD button to add the entry to the list box.
- Repeat the above steps for each new entry.
- To edit an entry, select it from the list box, modify its values in the text boxes and click on the MODIFY button to register the changes.
- To delete an entry, select it from the list box and click on the DELETE button.

To define spring supports:

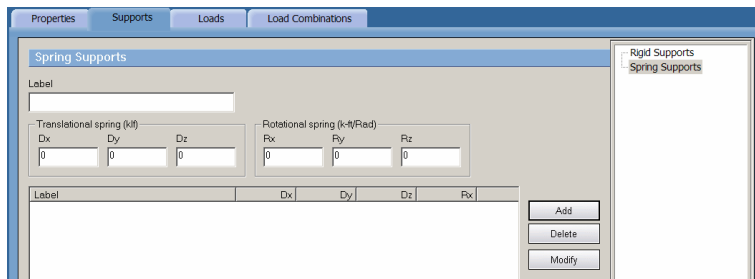

- Click on SPRING SUPPORTS... found in the right ITEM LISTING AREA to have the program surface the Spring Supports input screen.
- Enter a label or ID in the LABEL text box.
- Enter translational and rotational spring values in the respective text boxes.
- Click on the ADD button to add the entry to the list box.
- Repeat the above steps for each new entry.

- To edit an entry, select it from the list box, modify its values in the text boxes and click on the **MODIFY** button to register the changes.
- To delete an entry, select it from the list box and click on the **DELETE** button.

Defining Loads

Nodal and element loads are defined using the **Define / Loads** command. From the **Define** menu, choose **Loads** to have the program surface the **LOADS** folder. Alternatively, you could have clicked on the **Define** button located on the toolbar, and then on the **LOADS** tab.

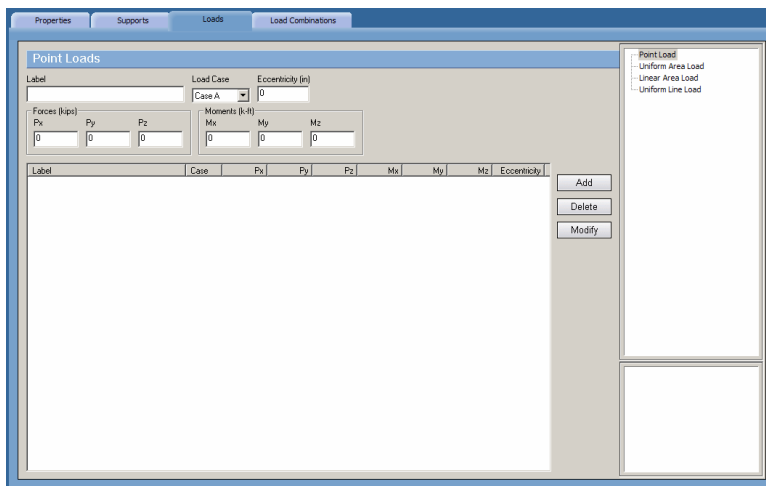

To define point loads:

- Click on **POINT LOADS...** found in the right **ITEM LISTING AREA** to have the program surface the **Point Loads** input screen...
- Enter a label or ID in the **LABEL** text box.
- From the **LOAD CASE** drop-down list, select a load case (A through F). Note that loads defined under a particular load case may be applied to the wall under that load case only.
- Enter **Eccentricity** that is measured in the Z direction normal to the mid plane of the wall. If eccentricity is specified, additional moments will be applied at the node at which the point load is acting as explained in chapter 2.

- Enter forces (P_x , P_y and P_z) and moments (M_x , M_y and M_z). Note that forces are positive if they act in the positive direction of the corresponding axis. To determine the sign of the moments use the right hand rule.
- Click on the ADD button to add the entry to the list box.

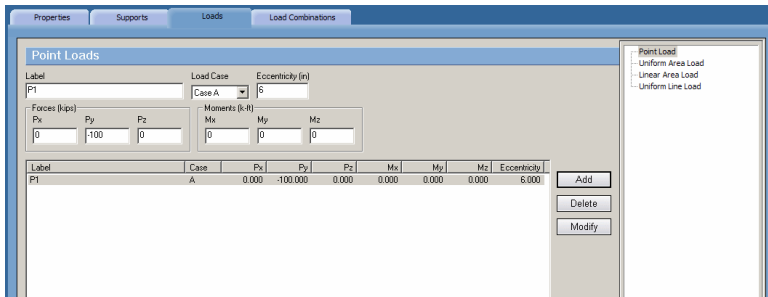

- Repeat the above steps for each new entry.
- To edit an entry, select it from the list box, modify its values in the text boxes and click on the MODIFY button to register the changes.
- To delete an entry, select it from the list box and click on the DELETE button.

To define uniform area loads:

- Click on UNIFORM AREA LOADS... found in the right ITEM LISTING AREA to have the program surface the Uniform Area Loads input screen...

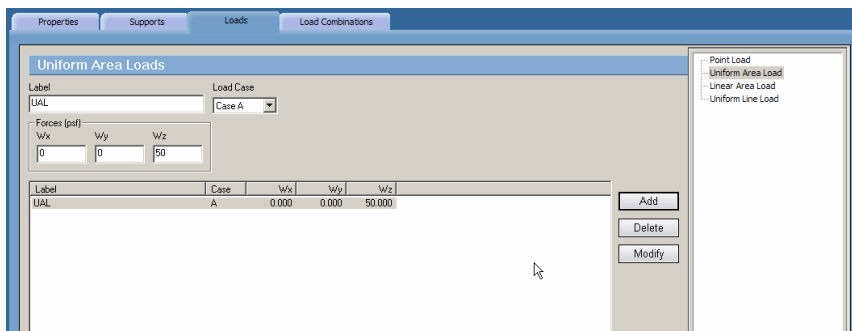

- Enter a label ID in the LABEL text box.
- From the LOAD CASE drop-down list, select a load case (A through F). Note that loads defined under a particular load case may be applied to the wall under that load case only.

- Enter the load intensity W_x , W_y and W_z as a force per unit area. Note that forces are positive if they act in the positive direction of the corresponding axis.
- Click on the ADD button to add the entry to the list box.
- Repeat the above steps for each entry.
- To edit an entry, select it from the list box, modify its values in the text boxes and click on the MODIFY button to register the changes.
- To delete an entry, select it from the list box and click on the DELETE button.

To define linear area loads:

- Click on LINEAR AREA LOADS... found in the right ITEM LISTING AREA to have the program surface the Linear Area Loads input screen...

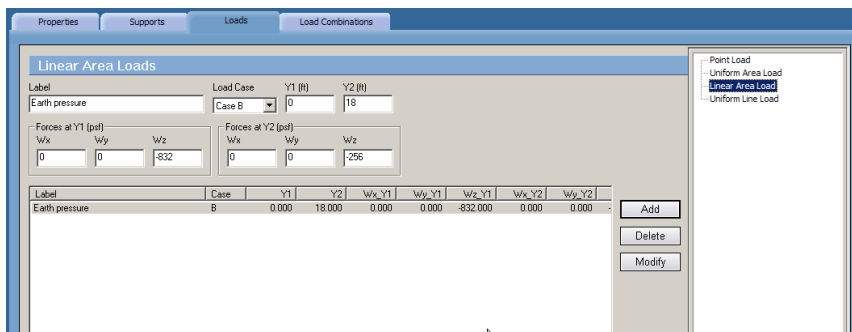

- Enter a label ID in the LABEL text box.
- From the LOAD CASE drop-down list, select a load case (A through F). Note that loads defined under a particular load case may be applied to the wall under that load case only.
- Enter Y1 and Y2. These are the two Y-coordinates at which the load intensities are specified.
- Enter the load intensity W_x , W_y and W_z as a force per unit area at both Y1 and Y2. Note that forces are positive if they act in the positive direction of the corresponding axis.
- Click on the ADD button to add the entry to the list box.
- Repeat the above steps for each entry.

- To edit an entry, select it from the list box, modify its values in the text boxes and click on the MODIFY button to register the changes.
- To delete an entry, select it from the list box and click on the DELETE button.

To define uniform line loads:

- Click on UNIFORM LINE LOADS... found in the right ITEM LISTING AREA to have the program surface the Uniform Line Loads input screen...

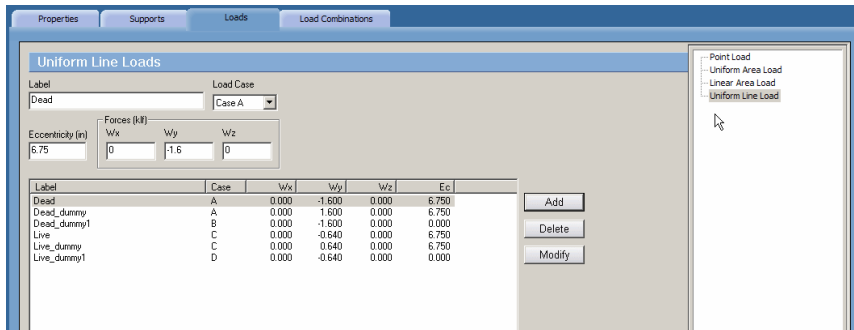

Label	Case	Wx	Wy	Wz	Ec
Dead	A	0.000	-1.600	0.000	6.750
Dead_dummy	A	0.000	1.600	0.000	6.750
Dead_dummy1	B	0.000	-1.500	0.000	0.000
Live	C	0.000	-0.640	0.000	6.750
Live_dummy	C	0.000	0.640	0.000	6.750
Live_dummy1	D	0.000	-0.640	0.000	0.000

- Enter a label or ID in the LABEL text box.
- From the LOAD CASE drop-down list, select a load case (A through F). Note that loads defined under a particular load case may be applied to the wall under that load case only.
- Enter Eccentricity that is measured in the Z direction normal to the mid plane of the wall. If eccentricity is specified, additional moments will be applied at the node at which the point load is acting as explained in chapter 2.
- Enter forces (W_x , W_y and W_z). Note that forces are positive if they act in the positive direction of the corresponding axis.
- Click on the ADD button to add the entry to the list box.
- Repeat the above steps for each new entry.
- To edit an entry, select it from the list box, modify its values in the text boxes and click on the MODIFY button to register the changes.
- To delete an entry, select it from the list box and click on the DELETE button.

Defining Load Combinations

Loads are applied to nodes and elements under six load cases (A through F). The load cases are combined under load combinations and the analysis is performed for

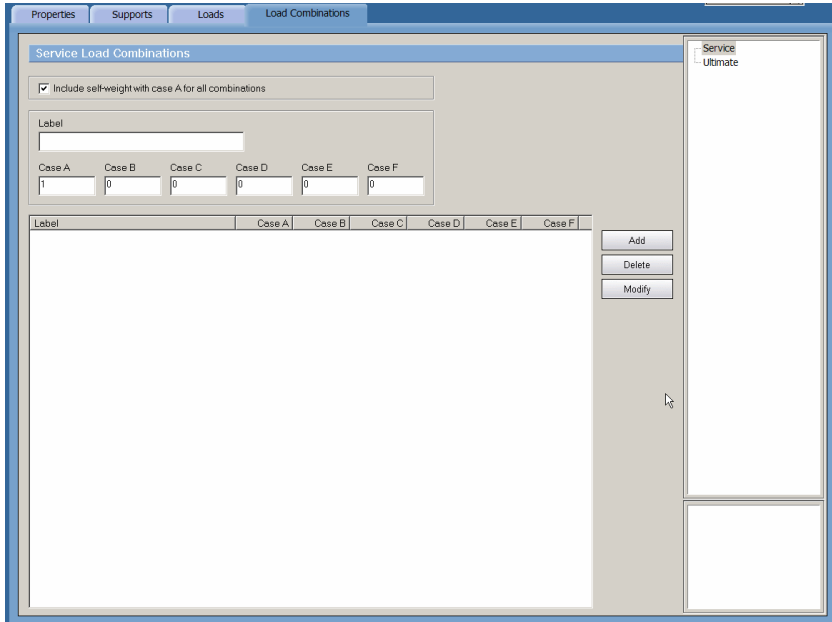

each load combination. For model analysis to be performed, there should be one service and one ultimate load combinations defined.

From the **Define** menu, choose **Load Combinations** to have the program surface the LOAD COMBINATIONS folder as illustrated here. Alternatively, you could have clicked on the **Define** button located on the toolbar, and then on the LOAD COMBINATIONS tab.

To define service load combinations:

- Click on SERVICE... found in the right ITEM LISTING AREA to have the program surface the Service Load Combinations input screen...
- Enter a label or ID in the LABEL text box.
- Enter load factors for each load case (A through F).

- Click the ADD button to add the load combination to the list box.
- Repeat above steps for each load combination entry.
- To edit an entry, select it from the list box, modify its values in the text boxes and click on the MODIFY button to register the changes.
- To delete an entry, select it from the list box and click on the DELETE button.

To define ultimate load combinations:

- Click on ULTIMATE... found in the right ITEM LISTING AREA to have the program surface the Ultimate Load Combinations input screen...
- Enter a label or ID in the LABEL text box.
- Enter load factors for each load case (A through F).
- Click the ADD button to add the load combination to the list box.
- Repeat the above steps for each load combination entry.
- To edit an entry, select it from the list box, modify its values in the text boxes and click on the MODIFY button to register the changes.
- To delete an entry, select it from the list box and click on the DELETE button.

Assigning Properties

Once the grid, all components, material properties, design criteria, loads and load combinations have been defined, you are ready to start assigning them - thereby putting the project together.

- From the Assign menu, choose **Properties** to have the program surface the PROPERTIES folder as illustrated here...

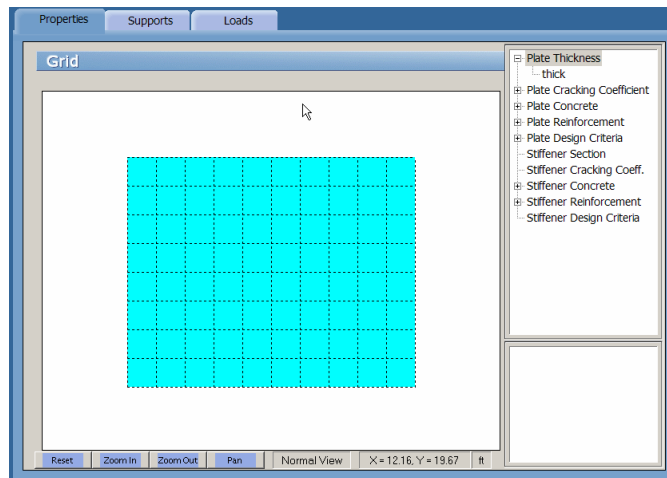

Alternatively, you could have clicked on the **Assign** button located on the toolbar, and then on the PROPERTIES tab.

To assign plate element thickness:

- Click on the **+** symbol next to PLATE THICKNESS... found in the right ITEM LISTING AREA to expand the PLATE THICKNESS list. The list items that will appear are those defined using the **Define / Plate Thickness** command. See *To define plate element thickness*.
- Select the list item to be assigned. This becomes the active assignment. By default, the program will display all elements that share the active assignment in red and the inactive assignment in cyan. Unassigned grid space is by default displayed in white. Recall however that you may change the color preferences to your liking with the **Options / Display Preferences** command. See *To change display preferences*.

- In the GRAPHICS AREA, using the left-mouse button, marquee-select a grid space or a group of grid spaces (or click a single grid space). The selected grid spaces are shown in red or in the color specified for ACTIVE OBJECTS in the DISPLAY folder. See *To change display preferences*.
- To delete an element, remove its thickness assignment. To do so, repeat the step above using instead, the right mouse button.
- Repeat the three steps above for each thickness assignment.

To assign plate cracking coefficient:

- Click on the **+** symbol next to PLATE CRACKING COEFFICIENTS... found in the right ITEM LISTING AREA to expand the PLATE CRACKING COEFFICIENTS list. The list items that will appear are those defined using the **Define / Plate Cracking Coefficients** command. See *To define plate cracking coefficients*.
- Select the list item to be assigned. This becomes the active assignment. By default, the program will display all plate elements that share the active assignment in red and the inactive assignment in cyan. Plate elements having no assignments are by default displayed in light grey. Grid spaces with no plate element assigned are by default displayed in white. Recall however that you may change the color preferences to your liking with the **Options / Display Preferences** command. See *To change display preferences*.
- In the GRAPHICS AREA, using the left-mouse button, marquee-select a plate element or a group of elements (or click a single plate element). The selected elements are shown in red or in the color specified for ACTIVE OBJECTS in the DISPLAY folder. See *To change display preferences*.
- To remove the assignment, repeat the step above using instead, the right mouse button.
- Repeat the steps above for each assignment.

To assign plate concrete material:

- Click on the **+** symbol next to PLATE CONCRETE... found in the right ITEM LISTING AREA to expand the PLATE CONCRETE list. The list items that will appear are those defined using the **Define / Concrete** command. See *To define concrete properties*.
- Select the list item to be assigned. This becomes the active assignment. By default, the program will display all plate elements that share the active

assignment in red and the inactive assignment in cyan. Plate elements having no assignments are by default displayed in light grey. Grid spaces with no plate element assigned are by default displayed in white. Recall however that you may change the color preferences to your liking with the **Options / Display Preferences** command. See *To change display preferences*.

- In the GRAPHICS AREA, using the left-mouse button, marquee-select a plate element or a group of elements (or click a single plate element). The selected plate elements are shown in red or in the color specified for ACTIVE OBJECTS in the DISPLAY folder. See *To change display preferences*.
- To remove the assignment, repeat the step above using instead, the right mouse button.
- Repeat the steps above for each assignment.

To assign plate reinforcing steel material:

- Click on the  symbol next to PLATE REINFORCEMENT... found in the right ITEM LISTING AREA to expand the PLATE REINFORCEMENT list. The list items that will appear are those defined using the **Define / Reinforcement** command. See *To define reinforcing steel properties*.
- Select the list item to be assigned. This becomes the active assignment. By default, the program will display all plate elements that share the active assignment in red and the inactive assignment in cyan. Plate elements having no assignments are by default displayed in light grey. Grid spaces with no plate element assigned are by default displayed in white. Recall however that you may change the color preferences to your liking with the **Options / Display Preferences** command. See *To change display preferences*.
- In the GRAPHICS AREA, using the left-mouse button, marquee-select a plate element or a group of elements (or click a single plate element). The selected plate elements are shown in red or in the color specified for ACTIVE OBJECTS in the DISPLAY folder. See *To change display preferences*.
- To remove the assignment, repeat the step above using instead, the right mouse button.
- Repeat the steps above for each assignment.

To assign plate design criteria:

- Click on the  symbol next to PLATE DESIGN CRITERIA... found in the right ITEM LISTING AREA to expand the PLATE DESIGN CRITERIA list. The list items that will appear are those defined using the **Define / Plate Design Criteria** command. See *To define plate design criteria*.
- Select the list item to be assigned. This becomes the active assignment. By default, the program will display all plate elements that share the active assignment in red and the inactive assignment in cyan. Plate elements having no assignments are by default displayed in light grey. Grid spaces with no plate element assigned are by default displayed in white. Recall however that you may change the color preferences to your liking with the **Options / Display Preferences** command. See *To change display preferences*.
- In the GRAPHICS AREA, using the left-mouse button, marquee-select a plate element or a group of elements (or click a single plate element). The selected plate elements are shown in red or in the color specified for ACTIVE OBJECTS in the DISPLAY folder. See *To change display preferences*.
- To remove the assignment, repeat the step above using instead, the right mouse button.
- Repeat the steps above for each assignment.

To assign stiffener element section:

- Click on the  symbol next to STIFFENER SECTION... found in the right ITEM LISTING AREA to expand the STIFFENER SECTION list. The list items that will appear are those defined using the **Define / Stiffener Section** command. See *To define stiffener element section*.
- Select the list item to be assigned. This becomes the active assignment. By default, the program will display all stiffener elements that share the active assignment in red and the inactive assignment in cyan. Stiffener elements having no assignments are by default displayed in blue. Recall however that you may change the color preferences to your liking with the **Options / Display Preferences** command. See *To change display preferences*.
- In the GRAPHICS AREA, using the left-mouse button, marquee-select a grid segment or a group of grid segments. The selected grid segments are shown in red or in the color specified for ACTIVE OBJECTS in the DISPLAY folder. See *To change display preferences*.

- To delete an element, remove its section assignment. To do so, repeat the step above using instead, the right mouse button.
- Repeat the three steps above for each section assignment.

To assign stiffener cracking coefficient:

- Click on the  symbol next to STIFFENER CRACKING COEFFICIENTS... found in the right ITEM LISTING AREA to expand the STIFFENER CRACKING COEFFICIENTS list. The list items that will appear are those defined using the **Define / Stiffener Cracking Coefficients** command. See *To define stiffener cracking coefficients*.
- Select the list item to be assigned. This becomes the active assignment. By default, the program will display all stiffener elements that share the active assignment in red and the inactive assignment in cyan. . Stiffener elements having no assignments are by default displayed in blue. Recall however that you may change the color preferences to your liking with the **Options / Display Preferences** command. See *To change display preferences*.
- In the GRAPHICS AREA, using the left-mouse button, marquee-select a stiffener element or a group of stiffener elements. The selected stiffener elements are shown in red or in the color specified for ACTIVE OBJECTS in the DISPLAY folder. See *To change display preferences*.
- To remove the assignment, repeat the step above using instead, the right mouse button.
- Repeat the steps above for each assignment.

To assign stiffener concrete material:

- Click on the  symbol next to STIFFENER CONCRETE... found in the right ITEM LISTING AREA to expand the STIFFENER CONCRETE list. The list items that will appear are those defined using the **Define / Concrete** command. See *To define concrete properties*.
- Select the list item to be assigned. This becomes the active assignment. By default, the program will display all stiffener elements that share the active assignment in red and the inactive assignment in cyan. . Stiffener elements having no assignments are by default displayed in blue. Recall however that you may change the color preferences to your liking with the **Options / Display Preferences** command. See *To change display preferences*.

- In the GRAPHICS AREA, using the left-mouse button, marquee-select a stiffener element or a group of stiffener elements. The selected stiffener elements are shown in red or in the color specified for ACTIVE OBJECTS in the DISPLAY folder. See *To change display preferences*.
- To remove the assignment, repeat the step above using instead, the right mouse button.
- Repeat the steps above for each assignment.

To assign stiffener reinforcing steel material:

- Click on the **+** symbol next to STIFFENER REINFORCEMENT... found in the right ITEM LISTING AREA to expand the STIFFENER REINFORCEMENT list. The list items that will appear are those defined using the **Define / Reinforcement** command. See *To define reinforcing steel properties*.
- Select the list item to be assigned. This becomes the active assignment. By default, the program will display all stiffener elements that share the active assignment in red and the inactive assignment in cyan. . Stiffener elements having no assignments are by default displayed in blue. Recall however that you may change the color preferences to your liking with the **Options / Display Preferences** command. See *To change display preferences*.
- In the GRAPHICS AREA, using the left-mouse button, marquee-select a stiffener element or a group of stiffener elements. The selected stiffener elements are shown in red or in the color specified for ACTIVE OBJECTS in the DISPLAY folder. See *To change display preferences*.
- To remove the assignment, repeat the step above using instead, the right mouse button.
- Repeat the steps above for each assignment.

To assign stiffener design criteria:

- Click on the **+** symbol next to STIFFENER DESIGN CRITERIA... found in the right ITEM LISTING AREA to expand the STIFFENER DESIGN CRITERIA list. The list items that will appear are those defined using the **Define / Stiffener Design Criteria** command. See *To define stiffener design criteria*.
- Select the list item to be assigned. This becomes the active assignment. By default, the program will display all stiffener elements that share the active assignment in red and the inactive assignment in cyan. . Stiffener elements

having no assignments are by default displayed in blue. Recall however that you may change the color preferences to your liking with the **Options / Display Preferences** command. See *To change display preferences*.

- In the GRAPHICS AREA, using the left-mouse button, marquee-select a stiffener element or a group of stiffener elements. The selected stiffener elements are shown in red or in the color specified for ACTIVE OBJECTS in the DISPLAY folder. See *To change display preferences*.
- To remove the assignment, repeat the step above using instead, the right mouse button.
- Repeat the steps above for each assignment.

Assigning Supports

Once plate and stiffener elements are assigned, the program creates finite element nodes. A node is a grid intersection that has an element or more connected to it. Supports are assigned only to nodes

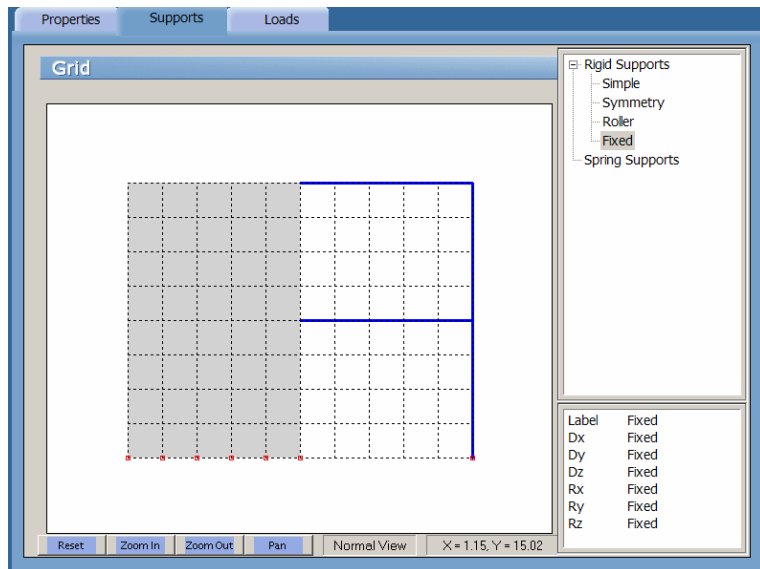

- From the **Assign** menu, choose **Supports** surface the SUPPORTS folder as illustrated above...

Alternatively, you could have clicked on the  button located on the toolbar, and then on the SUPPORTS tab.

To assign rigid supports:

- Click on the  symbol next to RIGID SUPPORTS ... found in the right ITEM LISTING AREA to expand the Rigid Supports list. The list items that will appear are those defined using the **Define / Supports/ Rigid Supports** command. See *To define rigid supports*.
- Select a list item to be assigned. This becomes the active assignment. By default, the program will display all nodes that share the active assignment in red and nodes with a different assignment in cyan. Recall however that you may change the color preferences to your liking with the **Options / Display Preferences** command. See *To change display preferences*.
- In the GRAPHICS AREA, using the left-mouse button, marquee-select a node or a group of nodes (or click a single node). The selected nodes are shown in red or in the color specified for ACTIVE OBJECTS in the DISPLAY folder. See *To change display preferences*.
- To remove the assignment, repeat the step above using instead, the right mouse button.
- Repeat the steps above for each assignment.

To assign spring supports:

- Click on the  symbol next to SPRING SUPPORTS ... found in the right ITEM LISTING AREA to expand the Spring Supports list. The list items that will appear are those defined using the **Define / Supports/ Spring Supports** command. See *To define spring supports*.
- Select a list item to be assigned. This becomes the active assignment. By default, the program will display all nodes that share the active assignment in red and nodes with a different assignment in cyan. Recall however that you may change the color preferences to your liking with the **Options / Display Preferences** command. See *To change display preferences*.
- In the GRAPHICS AREA, using the left-mouse button, marquee-select a node or a group of nodes (or click a single node). The selected nodes are shown in red or in the color specified for ACTIVE OBJECTS in the DISPLAY folder. See *To change display preferences*.

- To remove the assignment, repeat the step above using instead, the right mouse button.
- Repeat the steps above for each assignment.

Applying Loads

Once plate and stiffener elements are assigned, the program creates finite element nodes. A node is a grid intersection that has an element or more connected to it. Point loads are assigned to nodes. Area loads are assigned to plate elements. Line loads are assigned to either stiffener elements or to the edges of plate elements.

- From the **Assign** menu, choose **Loads** to have the program surface the LOADS folder as illustrated here...

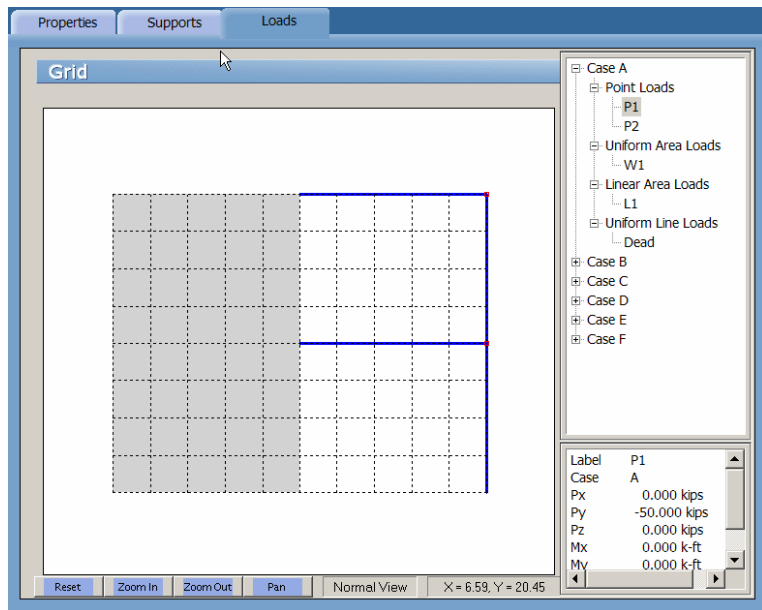

Alternatively, you could have clicked on the **Assign** button located on the toolbar, and then on the LOADS tab.

To assign point loads:

- Click on the **+** symbol next to required load case (CASE A, CASE B etc.) found in the right ITEM LISTING AREA to expand the list. Click on the **+**

symbol next to POINT LOADS. The list items that will appear are those defined using the **Define / Loads/ Point Loads** command. See *To define point loads*.

- Select a list item to be assigned. This becomes the active assignment. By default, the program will display all nodes that share the active assignment in red and nodes with a different assignment in cyan. Recall however that you may change the color preferences to your liking with the **Options / Display Preferences** command. See *To change display preferences*.
- In the GRAPHICS AREA, using the left-mouse button, marquee-select a node or a group of nodes (or click a single node). The selected nodes are shown in red or in the color specified for ACTIVE OBJECTS in the DISPLAY folder. See *To change display preferences*.
- To remove the assignment, repeat the step above using instead, the right mouse button.
- Repeat the steps above for each assignment.

To assign uniform area loads:

- Click on the **+** symbol next to required load case (CASE A, CASE B etc.) found in the right ITEM LISTING AREA to expand the list. Click on the **+** symbol next to UNIFORM AREA LOADS. The list items that will appear are those defined using the **Define / Loads/ Uniform Area Loads** command. See *To define uniform area loads*.
- Select the list item to be assigned. This becomes the active assignment. By default, the program will display all plate elements that share the active assignment in red and the inactive assignment in cyan. Plate elements having no assignments are by default displayed in light grey. Grid spaces with no plate element assigned are by default displayed in white. Recall however that you may change the color preferences to your liking with the **Options / Display Preferences** command. See *To change display preferences*.
- In the GRAPHICS AREA, using the left-mouse button, marquee-select a plate element or a group of elements (or click a single plate element). The selected plate elements are shown in red or in the color specified for ACTIVE OBJECTS in the DISPLAY folder. See *To change display preferences*.
- To remove the assignment, repeat the step above using instead, the right mouse button.
- Repeat the steps above for each assignment.

To assign Linear area loads:

- Click on the **+** symbol next to required load case (CASE A, CASE B etc.) found in the right ITEM LISTING AREA to expand the list. Click on the **+** symbol next to LINEAR AREA LOADS. The list items that will appear are those defined using the **Define / Loads/ Linear Area Loads** command. See *To define linear area loads*.
- Select the list item to be assigned. This becomes the active assignment. By default, the program will display all plate elements that share the active assignment in red and the inactive assignment in cyan. Plate elements having no assignments are by default displayed in light grey. Grid spaces with no plate element assigned are by default displayed in white. Recall however that you may change the color preferences to your liking with the **Options / Display Preferences** command. See *To change display preferences*.
- In the GRAPHICS AREA, using the left-mouse button, marquee-select a plate element or a group of elements (or click a single plate element). The selected plate elements are shown in red or in the color specified for ACTIVE OBJECTS in the DISPLAY folder. See *To change display preferences*.
- To remove the assignment, repeat the step above using instead, the right mouse button.
- Repeat the steps above for each assignment.

To assign uniform line loads:

- Click on the **+** symbol next to required load case (CASE A, CASE B etc.) found in the right ITEM LISTING AREA to expand the list. Click on the **+** symbol next to UNIFORM LINE LOADS. The list items that will appear are those defined using the **Define / Loads/ Uniform Line Loads** command. See *To define uniform line loads*.
- Select the list item to be assigned. This becomes the active assignment. By default, the program will display all lines that share the active assignment in red and the inactive assignment in cyan. Recall however that you may change the color preferences to your liking with the **Options / Display Preferences** command. See *To change display preferences*.
- In the GRAPHICS AREA, using the left-mouse button, marquee-select a stiffener element, a group of stiffener elements, a plate element edge or a group of plate element edges. The selected lines are shown in red or in the color

specified for ACTIVE OBJECTS in the DISPLAY folder. See *To change display preferences*.

- To remove the assignment, repeat the step above using instead, the right mouse button.
- Repeat the steps above for each assignment.

Solving the Structural Model

Once the structural model has been completed, the user can proceed to solve it. Solving the model is done in two steps. The first is the finite element analysis. In the second step, the program calculates the required area of steel for the plate and the stiffener elements.

By selecting the **Run Analysis & Design** command from the **Solve** menu, the program will perform the first step and automatically execute the second step. Changing any of the model properties that render the finite element analysis invalid, this command has to be re-invoked for the solution to be complete. However, changing the definition of reinforcing steel or design criteria does not affect the finite element analysis but cause the design step to be invalid. In this case, the user can run only the second step of the solution by selecting the **Run Design** command from the **Solve** menu.

When the analysis module is invoked, the following dialog box appears:

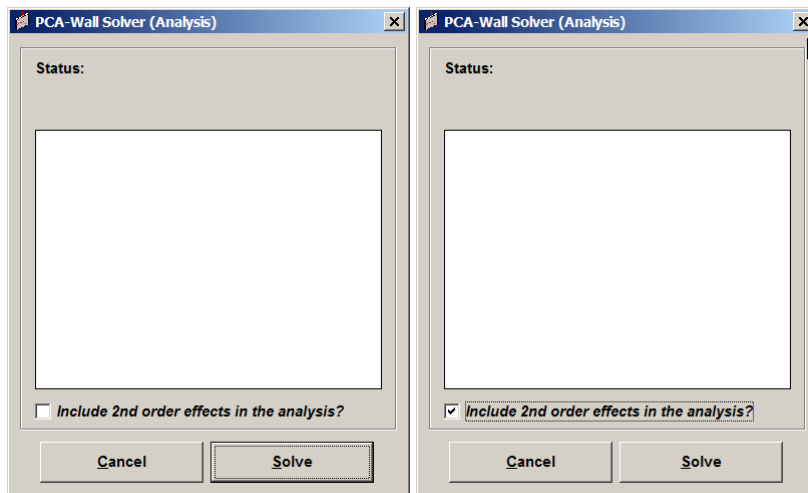

When the checkbox, INCLUDE 2ND ORDER EFFECT IN THE ANALYSIS?, is unchecked, the program perform *first order analysis*. When the checkbox is checked, the program perform second order analysis in which the out of plane (bending) action is magnified according to the values of the in plane forces and the out of plane deflections. See the discussion in chapter 2.

The user should click SOLVE button in order to complete the analysis process. Clicking the CANCEL button will cause the program to abort the solving procedure. After, the analysis process is complete, the user can click on the CLOSE button to accept the analysis results and let the program proceed to the design step or he/she can click the CANCEL button to disregard the analysis results and to abort the solving procedure.

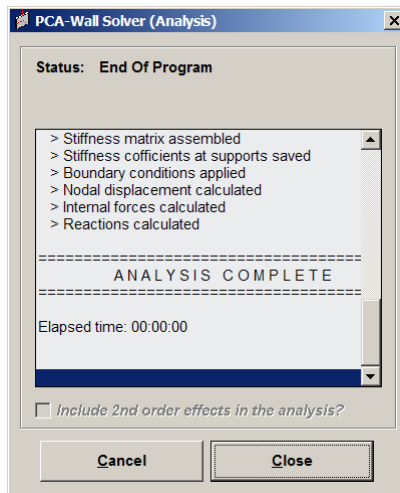

Viewing Results

After a successful run, the output may viewed be in tabular form using the **Solve / View Results** command.

- From the **Solve** menu, choose **View Results** to have the program surface the VIEW RESULTS folder as illustrated here...

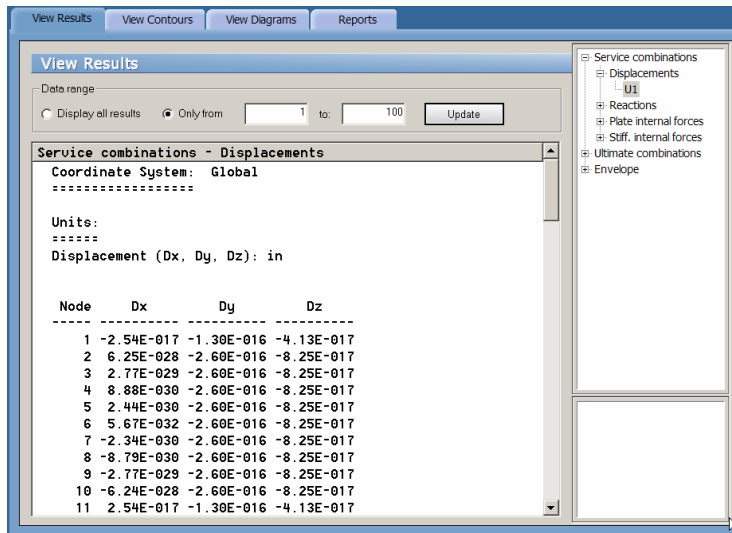

Alternatively, you could have clicked on the **Results** button located on the toolbar, and then on the VIEW RESULTS tab.

- The results are categorized into three types:

- Service Combination:

- Displacements

The displacements (D_x , D_y and D_z) at each node are displayed due the selected service load combination. Displacements are shown in the directions of the global axes.

- Reactions

The forces and moments at each restrained node are displayed due the selected service load combination. Forces and moments are shown in the directions of the global axes.

- Plate internal forces

The in-plane forces (N_{xx} , N_{yy} , N_{xy}), the bending moments (M_{xx} , M_{yy}) and the torsional moment (M_{xy}) in each plate element are displayed due the selected service load combination. Forces and moments are shown in the directions of the global axes.

- Stiffener internal forces

The internal forces (N , V_y and V_z), the internal bending moments (M_z , M_y) and the torsional moment (M_x) in each stiffener element are displayed due the selected service load combination. Forces and moments are shown in the directions of the local axes of the stiffener element. See the definition of stiffener local axes in chapter 2.

- Ultimate Combination:

- Displacements

The displacements (D_x , D_y and D_z) at each node are displayed due the selected ultimate load combination. Displacements are shown in the directions of the global axes.

- Reactions

The forces and moments at each restrained node are displayed due the selected ultimate load combination. Forces and moments are shown in the directions of the global axes.

- Plate internal forces

The in-plane forces (N_{xx} , N_{yy} , N_{xy}), the bending moments (M_{xx} , M_{yy}) and the torsional moment (M_{xy}) in each plate element are displayed due the selected ultimate load combination. Forces and moments are shown in the directions of the global axes.

- Stiffener internal forces

The internal forces (N , V_y and V_z), the internal bending moments (M_z , M_y) and the torsional moment (M_x) in each stiffener element are displayed due the selected ultimate load combination. Forces and moments are shown in the directions of the local axes of the stiffener element. See the definition of stiffener local axes in chapter 2.

- Envelopes

- Displacements

The maximum positive (+ve) and maximum negative (-ve) displacements (D_x , D_y and D_z) at each node are displayed. Displacement envelopes are calculated from the results of the

service load combinations. Displacements are shown in the directions of the global axes.

- Plate flexural reinforcements

The required areas of steel, in the X and the Y direction, in each plate element are reported. The results also show, the critical ultimate load combination that produces the smallest safety factor as well as the plate element design forces calculated for the critical load combination. See chapter 2 for discussion about calculating the design forces in plate elements.

- Stiffener flexural reinforcements

The portion of the longitudinal area of steel that resists flexure is reported for each stiffener element. The results also show, the critical ultimate load combination that produces the smallest safety factor as well as the stiffener element design forces calculated for the critical load combination.

- Stiffener shear reinforcements

The total required web reinforcement required to resist both shear and torsion is reported for each stiffener element. The results are shown for the y and z directions that are the local axes of the stiffener element. The results also show, the critical ultimate load combination that produces the smallest safety factor as well as the stiffener element design forces calculated for the critical load combination.

- Stiffener torsion reinforcements

The required web and longitudinal reinforcement required to resist torsion only are reported for each stiffener element. The results also show, the critical ultimate load combination that produces the smallest safety factor as well as the stiffener element design forces calculated for the critical load combination.

- Stiffener reinforcement summary

A summary of required web and longitudinal reinforcement required are reported for each stiffener element.

Viewing Contours

After a successful run, the output may be viewed graphically as contours using the **Solve / View Contours** command.

- From the Solve menu, choose **View Contours** to have the program surface VIEW CONTOURS folder as illustrated here...

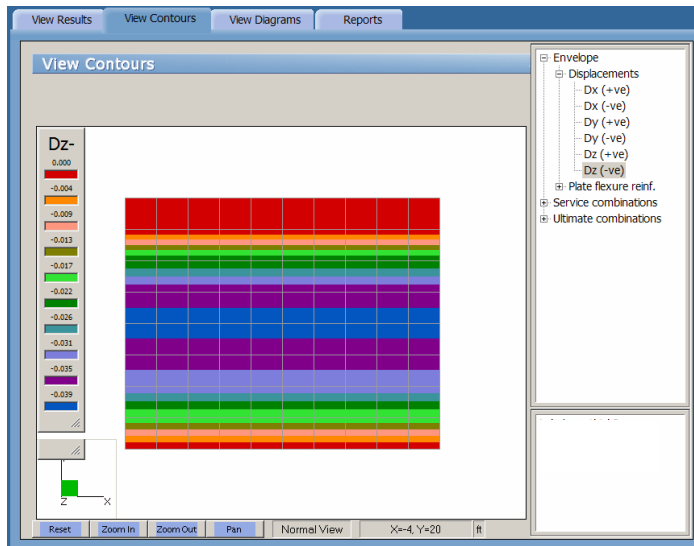

Alternatively, you could have clicked on the **Results** button located on the toolbar, and then on the VIEW CONTOURS tab.

- The results are categorized into three types:
 - Envelopes
 - Displacements

Contours for the maximum positive (+ve) and maximum negative (-ve) displacements (D_x , D_y and D_z) at each node are displayed. Displacement envelopes are calculated from the results of the service load combinations. Displacements are shown in the directions of the global axes.
 - Plate flexural reinforcements

Contours for the required areas of steel, in the X and the Y direction, in each plate element are displayed.

- Service Combinations
 - Displacements

The displacements (D_x , D_y and D_z) at each node are displayed due the selected service load combination. Displacements are shown in the directions of the global axes.
- Ultimate Combinations
 - Plate internal forces

The in-plane forces (N_{xx} , N_{yy} , N_{xy}), the bending moments (M_{xx} , M_{yy}) and the torsional moment (M_{xy}) in each plate element are displayed due the selected ultimate load combination. Forces and moments are shown in the directions of the global axes.
- To print the displayed contours, choose the **File / Print Screen** command.
- Using the left-mouse button, marquee select the portion of the graphical image you wish to enlarge. The selected area is enlarged to occupy the entire GRAPHICS / INPUT area.

Viewing Diagrams

After a successful run, some result items related to stiffener elements may be viewed graphically as diagrams using the **Solve / View Diagrams** command.

- From the **Solve** menu, choose **View Diagrams** to have the program surface the view diagrams folder as illustrated here...

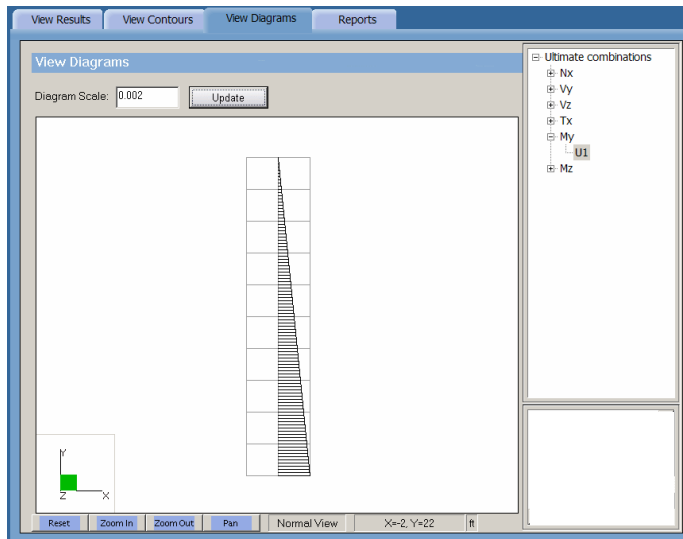

Alternatively, you could have clicked on the **Results** button located on the toolbar, and then on the **VIEW DIAGRAMS** tab.

- The results are available for one category only:
 - Ultimate Combinations
 - Stiffener internal forces

The internal forces (N , V_y and V_z), the internal bending moments (M_z , M_y) and the torsional moment (M_x) in each stiffener element are displayed due the selected ultimate load combination. Forces and moments are shown in the directions of the local axes of the stiffener element. See the definition of stiffener local axes in chapter 2.

- To print the displayed diagrams, choose the **File / Print Screen** command.
- Using the left-mouse button, marquee select the portion of the graphical image you wish to enlarge. The selected area is enlarged to occupy the entire GRAPHICS / INPUT area.

Defining the Options

There are many options that can be set as default so that they are saved to be applied to any subsequent project until they are changed again.

From the **Options** menu, choose **Startup Defaults**, **Autosave** or **Display** to have the program surface the respective OPTION folder as illustrated here.

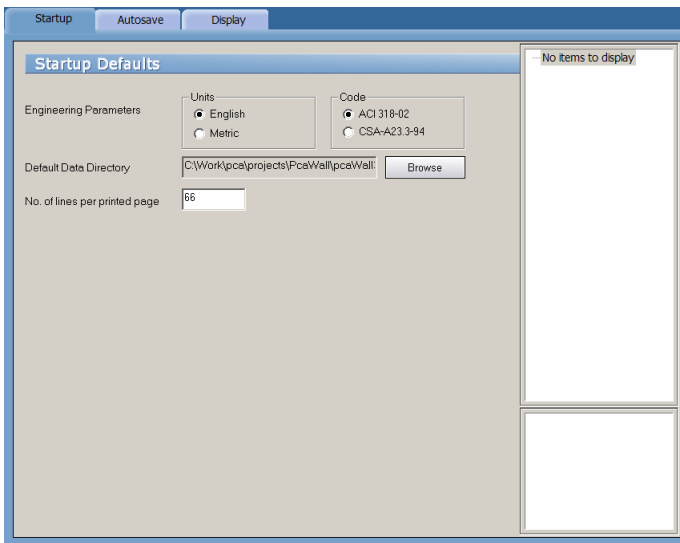

Alternatively, you could have clicked on the **Options** button located on the toolbar.

To Define startup defaults:

The **Options / Startup Defaults** command is used to save the current file settings to be used in future input sessions. Default settings are saved in the registry. Settings that are saved include units of measure, code, and default directories.

- With the STARTUP folder surfaced, from the UNITS options group, choose the applicable units of measure and from the CODE options group, select the appropriate design code.
- Specify a default data directory. The path you specify here is where any data files you save will be saved by default. Note, however, that you will still be able to specify a different location when you attempt to save. See *Saving the Data*.

- You may also specify the number of lines printed per page.

To Control the Autosave feature:

The **Options / Autosave** command is used to force the program to save your input data to disk at predefined intervals. This minimizes loss of data in case of a power loss or computer lock-up. Note that the file must be named (using the **File / Save As** command) prior to activating this feature.

- With the AUTOSAVE folder surfaced, place a checkmark in the ENABLE AUTOSAVE box to activate the auto save feature.
- In the Frequency text box, specify the time interval at which you would like the program to run the autosave feature.

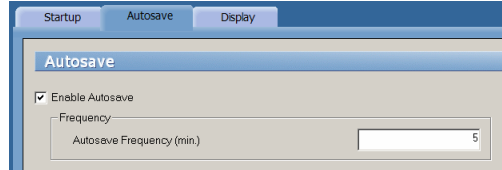

To Customize the display:

The **Options / Display** command is used to change the color settings of the graphical image to those of personal preference.

- With the DISPLAY folder surfaced, click on the CHOOSE FONT button to select the font type and size that will be used in plotting the node and element numbers on the graphical display. The font types that appear in the list are those saved in your WINDOWS/FONTS directory. The font you specify here is also used in screen-printing.
- Use the color drop-down lists within the OBJECT COLOR group to select preferred colors for the following...
 - Grid
 - Active (object, node or element)
 - Inactive (object, node or element)
 - Plate elements (without an assignment)
 - Stiffeners (without an assignment)
 - Background
- In the Display Preference group, the user can

- Turn on/off node numbers, plate element numbers and stiffener element numbers.
- Specify whether the grid lines to be displayed as solid or dotted lines.
- Specify the precision of the coordinates displayed in the status bar.

Chapter 5

Examples

Example 1

Design of the wall is required. Second order analysis should be performed. This example refers to example 21.1 in reference 1.

Design Data:

Concrete: $f_c = 4.0$ ksi, $w_c = 150$ pcf, $v = 0.15$.

Reinforcing steel: $f_y = 60.0$ ksi, $E_s = 29,000$ ksi.

Assume wall thickness = 6.5 in.

Assume eccentricity (e) = 6.75 in.

Roof dead load = 1.60 klf (line load)

Roof live load = 0.64 klf (line load)

Wind load = 20.0 psf (uniform area load)

Reinforcement is considered as one layer located in the middle of wall thickness.

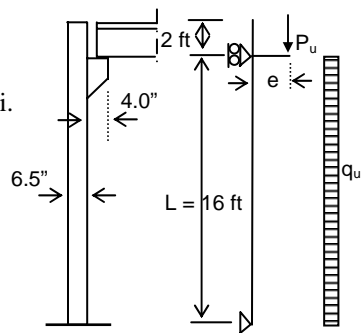

In reference 1, the eccentricity of the roof dead and live loads is assumed constant along the height of the wall. To simulate this case, dummy loads are applied at the lower edge of the beam.

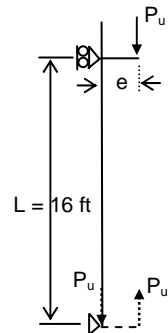

The wall acts as one way in the Y-direction. So, strip of 4 ft width is analyzed. The origin of the XY plane will be located at the lower left-hand corner of the wall. Two-foot square elements will be used; thus, the grid system consists of three grid lines, two feet apart, in the X-direction and 10 grid lines in the Y-direction.

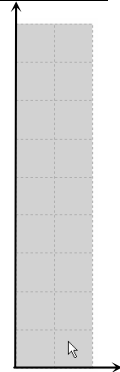

Inputting Problem Databases

1. From the **Define** menu, select **Project description** to surface the DESCRIPTION folder...

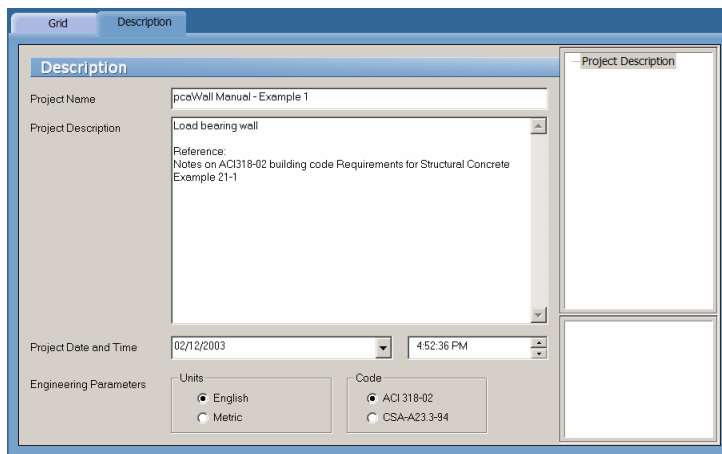

- Input the project information and select ENGLISH units along with the ACI code. Notice how the current date and time is displayed by default.
2. From the **Define** menu, select **Grid**, or simply click on the **Grid** tab to surface the respective folder...

Since the grid layout is uniform, and symmetrical in both directions, X and Y grid lines will be generated.

- Double-click on the GENERATE option in the ITEM LISTING AREA to have the program surface the following...

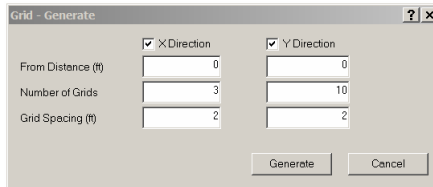

- Place a check mark in the X- DIRECTION box and enter the following values in the corresponding text boxes...

FROM DISTANCE:	0
NUMBER OF GRIDS:	3
GRID SPACING:	2
 - Place a check mark in the Y- DIRECTION box and enter the following values in the corresponding text boxes...

FROM DISTANCE:	0
NUMBER OF GRIDS:	10
Grid Spacing:	2
 - Click on the GENERATE button to return focus to the GRID folder. Notice how the X and Y grid lines now appear in the GRAPHICS/INPUT AREA.
3. From the **Define** menu, choose **Properties** to surface the PROPERTIES folder...

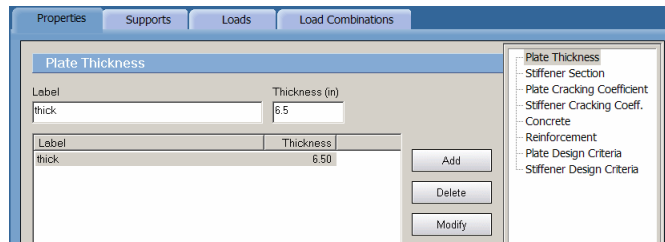

- Input Thick for LABEL and 6.5 for THICKNESS.
 - Click on the ADD button to add the entry to the list.
4. Click on the PLATE CRACKING COEFFICIENT option in the ITEM LISTING AREA to have the program surface the respective folder.
- Enter the following...

LABEL:	Cracking
--------	----------

IN PLANE: 1.0
 OUT OF PLANE: 0.05

- Click on the ADD button to add the entry to the list.

5. Click on the CONCRETE option in the ITEM LISTING AREA to have the program surface the respective folder.

- Enter the following...

LABEL: Conc
 UNIT WEIGHT: 150 pcf
 COMPRESSIVE STRENGTH: 4 ksi
 YOUNG'S MODULUS: 3834.25 ksi
 POISSON'S RATIO: 0.15

- Click on the ADD button to add the entry to the list.

6. Click on the REINFORCEMENT option in the ITEM LISTING AREA to have the program surface the respective folder.

- Enter the following...

LABEL: Steel
 YIELD STRENGTH: 60 ksi
 YOUNG'S MODULUS: 29000 ksi

- Click on the ADD button to add the entry to the list.

7. Click on the PLATE DESIGN CRITERIA option in the ITEM LISTING AREA to have the program surface the respective folder.

- Enter the following...

LABEL: DC
 NO. OF CURTAINS: ONE CURTAIN
 COVER TO HORIZ. BARS: 3.25 IN
 COVER TO VERTICAL BARS: 3.25 IN
 HORIZONTAL REINF. RATIO:
 MINIMUM: .2%
 MAXIMUM : 8%

VERTICAL REINF. RATIO:

MINIMUM: .12%
 MAXIMUM : 8%

- Click on the ADD button to add the entry to the list.
8. From the **Define** menu, select **Loads**, or simply click on the **Loads** tab to surface the respective folder...Click UNIFORM LINE LOAD from the Item Listing Area

- Enter the following

Load Case: A

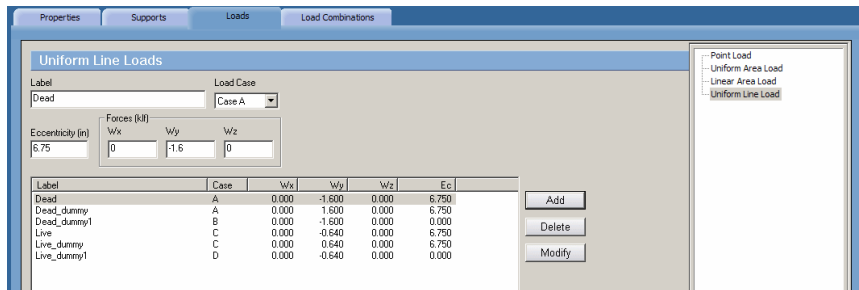

Label: Dead

Eccentricity: 6.75 in.

Wy: -1.6 klf

- Click on the ADD button to add the entry to the list.
- Enter the following

Load Case: A

Label: Dead _Dummy

Eccentricity: 6.75 in.

Wy: 1.6 klf

- Click on the ADD button to add the entry to the list.
- Enter the following

Load Case: B

Label: Dead _Dummy1

- Eccentricity: 0.0.
 - Wy: -1.6 klf
 - Click on the ADD button to add the entry to the list.
 - Enter the following...
 - Load Case: C
 - Label: Live
 - Eccentricity: 6.75 in.
 - Wy: -0.64' klf
 - Click on the ADD button to add the entry to the list.
 - Enter the following...
 - Load Case: C
 - Label: Live _dummy
 - Eccentricity: 6.75 in.
 - Wy: 0.64' klf
 - Click on the ADD button to add the entry to the list.
 - Enter the following...
 - Load Case: D
 - Label: Live _dummy
 - Eccentricity: 0.0
 - Wy: -0.64' klf
 - Click on the ADD button to add the entry to the list.
9. Click on the UNIFORM AREA LOAD option in the ITEM LISTING AREA to have the program surface the respective folder.
- Enter the following...
 - Load Case: E
 - Label: Wind
 - Wz: -20 psf
 - Click on the ADD button to add the entry to the list.

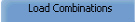
10. From the **Define** menu, choose **Load Combinations**, or simply click on the  tab to surface the respective folder...

- Check INCLUDE SELF-WEIGHT WITH CASE A FOR ALL LOAD COMBINATIONS

- Enter The following

LABEL:	S1
CASE A:	1.0
CASE B:	1.0
All other cases:	0.0

- Click on the ADD button to add the entry to the list.

11. Click on the **ULTIMATE** option in the **ITEM LISTING AREA** to have the program surface the respective folder.

- Enter the following...

LABEL:	1.2D+0.5L
CASE A & CASE B:	1.2
CASE C & CASE D:	0.5
All other cases:	0.0

- Click on the ADD button to add the entry to the list.

- Enter the following...

LABEL:	1.2D+1.6L+0.8W
CASE A & CASE B:	1.2
CASE C & CASE D:	1.6
CASE E:	0.8
All other cases:	0.0

- Enter the following...

LABEL:	1.2D+0.5L+1.6W
CASE A & CASE B:	1.2
CASE C & CASE D:	0.5
CASE E:	1.6
All other cases:	0.0

- Click on the ADD button to add the entry to the list.
- Enter the following...

LABEL:	0.9D+1.6W
CASE A & CASE B:	0.9
CASE C & CASE D:	0.0
CASE E:	1.6
All other cases:	0.0
- Click on the ADD button to add the entry to the list.

Assigning Properties

12. From the **Assign** menu, select **Properties** to surface the respective folder.
 - From the ITEM LISTING AREA, select THICK.
 - In the GRAPHICS/INPUT AREA, marquee-select the region (-1, 19)-(5, -1) to apply the selected thickness to the entire wall. The selected plate elements are redrawn in red.

Note: To see the assigned element and node numbers, from the **Define** menu, select Grid, and once the GRID folder surfaces, double click on PREFERENCES.
13. Click on the PLATE CRACKING COEFFICIENT option in the ITEM LISTING AREA.
 - Expand the SOIL listing in the ITEM LISTING AREA and select CRACKING.
 - In the GRAPHICS/INPUT AREA, marquee-select the region (-1, 19)-(5, -1) to apply the selected cracking coefficients to the entire wall. The selected plate elements are redrawn in red.
14. Repeat the step above using the **Concrete, Reinforcement** and **Plate Design Criteria** commands to apply CONC, STEEL and DC properties to the entire wall.

Assigning Loads

15. From the **Assign** menu, select **Loads** or simply click on the  tab to surface the respective folder.

- In the ITEM LISTING AREA, expand CASE A and then expand UNIFORM LINE LOADS to select DEAD.
- Marquee and apply load as shown in the figure below...

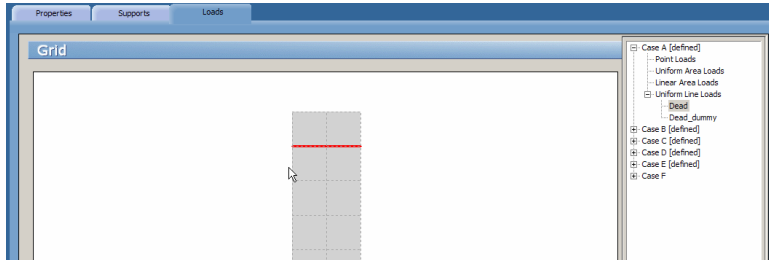

- Select and apply DEAD_DUMMY as shown in the figure below
- In the ITEM LISTING AREA, expand CASE B and then expand UNIFORM LINE LOADS to select DEAD_DUMMY1.
- Expand Case C and Apply loads LIVE and LIVE_DUMMY. Expand Case D and apply LIVE_Dummy1.

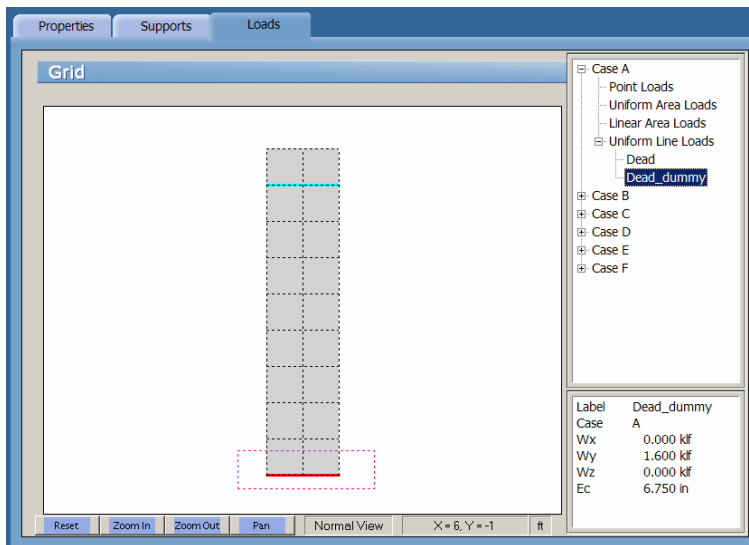

- In the ITEM LISTING AREA, expand CASE E and then expand UNIFORM AREA LOADS to select WIND In the ITEM LISTING AREA, expand CASE E and then expand UNIFORM AREA LOADS to select WIND.

- Marquee and apply load as shown in the figure below...

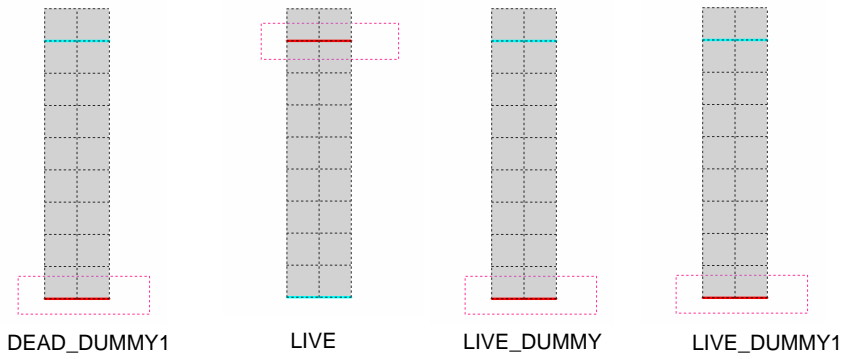

Solving

16. From the **Solve** menu, click **Run Analysis & Design** to surface the ANALYSIS dialog box...

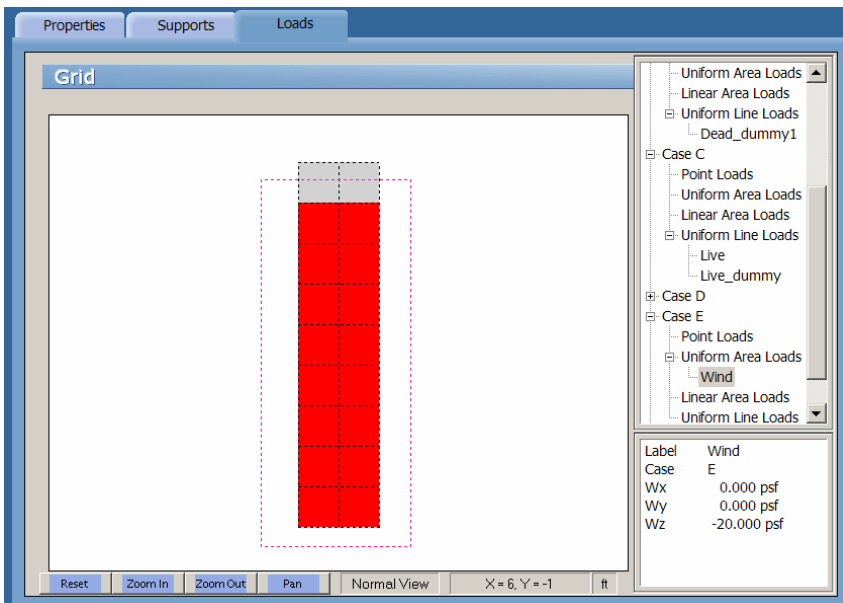

- Check: Include second order effects in analysis?

- Click on the SOLVE button.

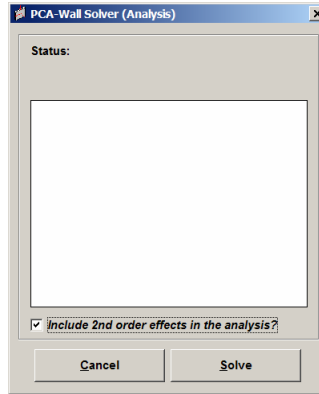

- The pcaWall Solver window is displayed and the solver messages are listed. After the solution is done focus will immediately be passed to the VIEW RESULTS folder.

Viewing and Printing Results

17. After a successful run, view results in text format by selecting an item from In the ITEM LISTING AREA.
18. Results can be viewed in a contour form by selecting the VIEW CONTOUR folder.

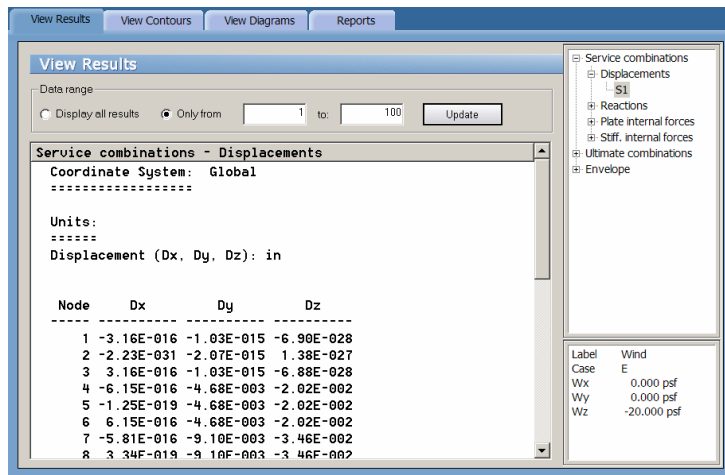

- To print the contour, select menu **File/Print Screen**. To print the results, Select **REPORTS** tab and follow the instructions outlined in chapter 4.

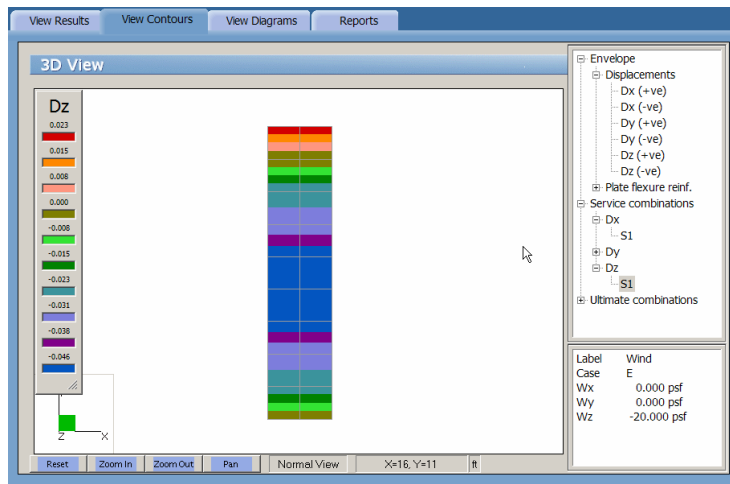

Example 2

Design the stem of the shown retaining wall. This example is the same as example 12.5 in reference 2.

Design Data:

Concrete: $f_c = 3.0$ ksi, $w_c = 150$ pcf,

Poisson's ratio = 0.15.

Reinforcing steel: $f_y = 40.0$ ksi, $E_s = 29,000.0$ ksi.

Assume wall thickness = 21 in.

Lateral earth pressure:

Due to soil weight = 576 psf

Due to surcharge = 256 psf

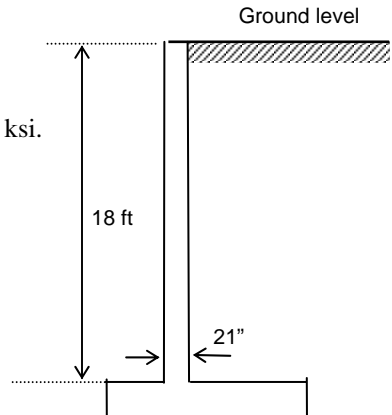

Fig. 2-a. Geometry

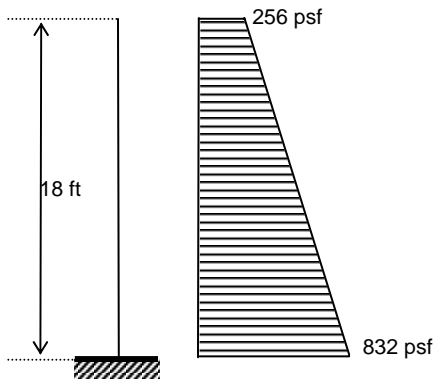

Figure 2-b Structural Model

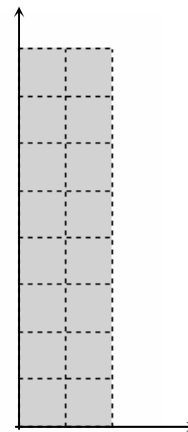
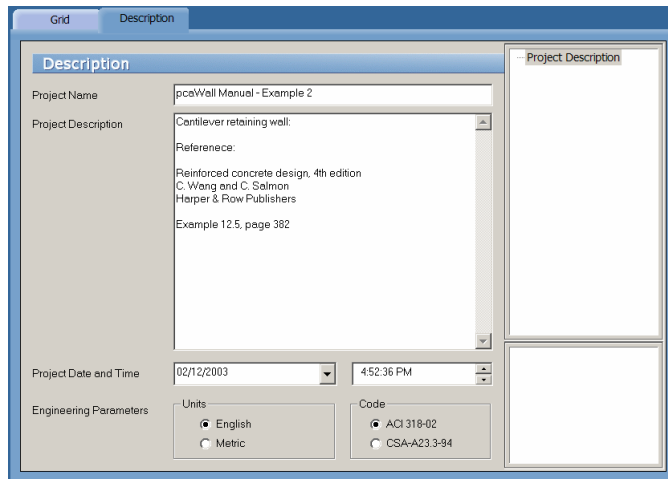

Figure 2-c Finite Element Mesh

The wall acts as one way in the Y-direction. So, strip of 4 ft width is analyzed. The origin of the XY plane will be located at the lower left-hand corner of the wall. Two-foot square elements will be used; thus, the grid system consists of three grid lines, two feet apart, in the X-direction and eight grid lines in the Y-direction. The finite element mesh is shown in figure (2.c).

Inputting Problem Databases

1. From the **Define** menu, select **Project description** to surface the DESCRIPTION folder...



- Input the project information and select ENGLISH units along with the ACI code. Notice how the current date and time is displayed by default.
2. From the **Define** menu, select **Grid**, or simply click on the **Grid** tab to surface the respective folder...

Since the grid layout is uniform, and symmetrical in both directions, X and Y grid lines will be generated.

- Double-click on the GENERATE option in the ITEM LISTING AREA to have the program surface the following...
- Place a check mark in the X- DIRECTION box and enter the following values in the corresponding text boxes...

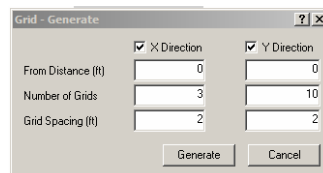

FROM DISTANCE: 0
 NUMBER OF GRIDS: 3
 GRID SPACING: 2

- Place a check mark in the Y- DIRECTION box and enter the following values in the corresponding text boxes...

FROM DISTANCE: 0
 NUMBER OF GRIDS: 10
 Grid Spacing: 2

- Click on the GENERATE button to return focus to the GRID folder. Notice how the X and Y grid lines now appear in the GRAPHICS/INPUT AREA.

- From the **Define** menu, choose **Properties** to surface the PROPERTIES folder...

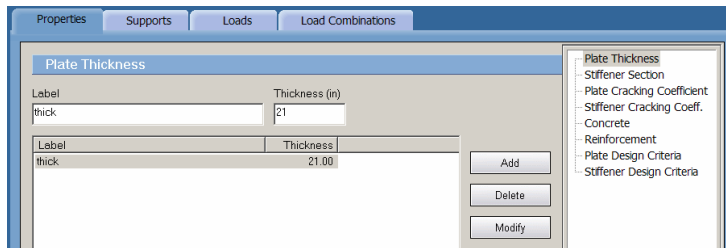

- Input Thick for LABEL and 12 in for THICKNESS.
- Click on the ADD button to add the entry to the list.

- Click on the CONCRETE option in the ITEM LISTING AREA to have the program surface the respective folder.

- Enter the following...

LABEL: Conc
 UNIT WEIGHT: 150 pcf
 COMPRESSIVE STRENGTH: 3 ksi
 YOUNG'S MODULUS: 3320.56 ksi
 POISSON'S RATIO: 0.15

- Click on the ADD button to add the entry to the list.

5. Click on the REINFORCEMENT option in the ITEM LISTING AREA to have the program surface the respective folder.
 - Enter the following...

LABEL:	Steel
YIELD STRENGTH:	40 ksi
YOUNG'S MODULUS:	29000 ksi

 - Click on the ADD button to add the entry to the list.

6. Click on the PLATE DESIGN CRITERIA option in the ITEM LISTING AREA to have the program surface the respective folder.
 - Enter the following...

LABEL:	DC
NO. OF CURTAINS:	TWO CURTAINS
COVER TO HORIZ. BARS:	3. in
COVER TO VERTICAL BARS:	2.5 in
HORIZONTAL REINF. RATIO:	
MINIMUM:	.2%
MAXIMUM :	8%
VERTICAL REINF. RATIO:	
MINIMUM:	.12%
MAXIMUM :	8%

 - Click on the ADD button to add the entry to the list.

7. From the **Define** menu, select **Loads**, or simply click on the  tab. Click on the LINEAR AREA LOAD option in the ITEM LISTING AREA to have the program surface the respective folder...

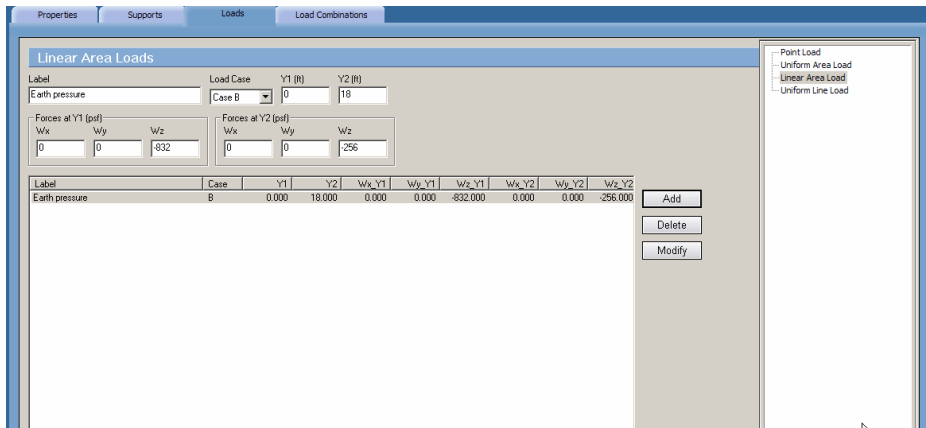

- Enter the following...

Load Case: B
 Label: Earth pressure
 Y1: 0.0 ft
 Y2: 18.0 ft
 Wz at Y1: -832 psf
 Wz at Y2: -256 psf

- Click on the ADD button to add the entry to the list.

8. From the **Define** menu, choose **Load Combinations**, or simply click on the **Load Combinations** tab to surface the respective folder...

- Check Include self-weight with case A for all load combinations

- Enter The following

LABEL: S1
 CASE A: 1.0
 CASE B: 1.0
 All other cases: 0.0

- Click on the ADD button to add the entry to the list.

9. Click on the **ULTIMATE** option in the **ITEM LISTING AREA** to have the program surface the respective folder.

- Enter the following...

LABEL: 1.4(D+F)

CASE A & CASE B: 1.4

All other cases: 0.0

- Click on the **ADD** button to add the entry to the list.

Assigning Properties

10. From the **Assign** menu, select **Properties** to surface the respective folder.

- From the **ITEM LISTING AREA**, select **THICK**.
- In the **GRAPHICS/INPUT AREA**, marquee-select the region (-1, 19)-(5, -1) to apply the selected thickness to the entire wall. The selected plate elements are redrawn in red.

Note: To see the assigned element and node numbers, from the **Define** menu, select **Grid**, and once the **GRID** folder surfaces, double click on **PREFERENCES**.

11. Repeat the step above using the **Concrete**, **Reinforcement** and **Plate Design Criteria** commands to apply **CONC**, **STEEL** and **DC** properties to the entire wall.

Assigning Loads

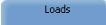
12. From the **Assign** menu, select **Loads** or simply click on the  tab to surface the respective folder.

- In the **ITEM LISTING AREA**, expand **CASE E** and then expand **UNIFORM AREA LOADS** to select **WIND** In the **ITEM LISTING AREA**, expand **CASE E** and then expand **UNIFORM AREA LOADS** to select **WIND**.
- Marquee and apply load as shown in the figure below...

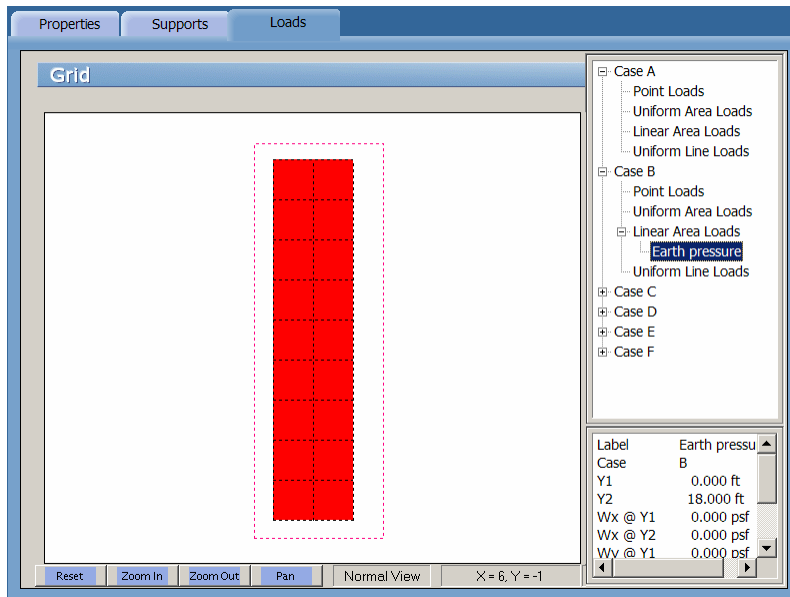

Solving

- From the **Solve** menu, click **Run Analysis & Design** to surface the ANALYSIS dialog box...

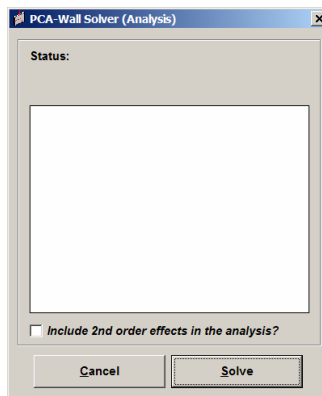

- Click on the SOLVE button.

Viewing and Printing Results

14. After a successful run, view results in text format by selecting an item from in the ITEM LISTING AREA.
15. Results can be viewed in a contour form by selecting the VIEW CONTOUR folder

References

1. *Notes on ACI 318-95 Building Code Requirements for Structural Concrete*, Portland Cement Association, 2002.
2. W.K. Wang and C.G. Salmon., *Reinforced Concrete Design*, Harper Row, Third Edition, 1985.

Appendix

Code Provisions

Flexure Design

A. ACI138-02

- ϕ (tension control) = .9 (9.3.2.1)
- ϕ (compression control) = 0.65 (9.3.2.2)
- Maximum usable $f_y = 80.0$ ksi (9.4)
- An elastic perfectly plastic stress-strain distribution is assumed for the reinforcing steel (10.2.4)
- Strains in concrete and steel are assumed directly proportional to the distance from neutral axis (10.2.2)
- Maximum concrete strain = .003 (10.2.3)
- Tensile strength of concrete is neglected (10.2.5)
- Equivalent rectangular stress distribution is used to represent the relationship between concrete compression stress and concrete strain (10.2.7)
 - f_c (stress block) = $0.85 f'_c$ (10.2.7.1)
 - $\beta_1 = 1.05 - .05 \quad 0.85 \geq f'_c \geq 0.65$ (10.2.7.3)
- Tension control starts at $\epsilon_s = 0.005$ (10.3.4)
- Compression control starts at $\epsilon_s = \epsilon_y$ (10.3.4)
- Maximum axial load strength (P_n) = $.8 P_o$ (10.3.6.2)

B. CSA23.3-94

- ϕ (concrete) = 0.6 (8.4.2)
- ϕ (steel) = 0.85 (8.4.2)
- Maximum usable steel f_y in tension = 500 MPa (8.5.1)
- Maximum usable steel f_y in compression = 400 MPa (8.5.2)
- An elastic perfectly plastic stress-strain distribution is assumed for the reinforcing steel (8.5.3.2)
- Maximum usable concrete $f'_c = 80$ MPa (8.6.1.1)
- Strains in concrete and steel are assumed directly proportional to the distance from neutral axis (10.1.2)
- Maximum concrete strain = .0035 (10.1.3)

- Tensile strength of concrete is neglected (10.1.5)
- Equivalent rectangular stress distribution is used to represent the relationship between concrete compression stress and concrete strain (10.1.7)
 - f_c (stress block) = $\alpha_1 \phi_c f_c'$
 $\alpha_1 = 0.85 - .0015 f_c' \geq 0.67$
 - $\beta_1 = 0.97 - .0025 f_c' \geq 0.67$
- Maximum factored axial load resistance (P_r) = $.8 P_{ro}$ (10.10.4)

Shear and Torsion Design

A. ACI138-02

- Definitions:
 d = Distance from extreme compression fiber to centroid of longitudinal tension reinforcement. For circular section $d \geq 0.8$ diameter
 b_w = Web width or diameter of circular section.

$$V_s = \frac{V_u}{\phi} - V_c \geq 0$$

$$v_c = \frac{V_c}{b_w d}$$

$$v_u = \frac{V_u}{\phi b_w d}$$

$$T_n = \frac{T_u}{\phi}$$

$$\tau_c = \left(\frac{T_u P_{cp}}{\phi A_{cp}^2} \right)$$

$$\tau_u = \left(\frac{T_u P_h}{\phi A_{oh}^2} \right)$$

- $\phi = 0.75$ (9.3.2)
- Maximum usable $f_{yv} = 60.0$ ksi (11.5.2)
- Lightweight concrete (11.2)
 - $\lambda = 1.0$ for $W_c \geq 145$ lb/ft
 - $\lambda = 0.85$ for $W_c = 125$ lb/ft³
 - $\lambda = 0.75$ for $W_c \leq 100$ lb/ft³

Linear relationship between W_c and λ is assumed between the abovementioned values.

- Shear strength provided by concrete:

$$V_c = 2 \left(1 - \frac{N_u}{2000 A_g} \right) \lambda \sqrt{f_c'} b_w d \quad N_u \leq 0 \text{ (compression)} \quad (11.3.1.2)$$

$$V_c = 2 \left(1 - \frac{N_u}{500 A_g} \right) \lambda \sqrt{f_c'} b_w d \geq 0 \quad N_u \geq 0 \text{ (tension)} \quad (11.3.2.3)$$

- Shear reinforcement

- Shear reinforcement should be provided if $v_u > 0.5 v_c$ (11.5.5.1)

- $$\frac{A_v}{s} = \frac{V_s}{f_{yv} d}$$
 (11.5.6.2)

- Maximum spacing of stirrups

$$0.5 d \leq 24 \text{ inches} \quad \text{for } V_s \leq 4 \sqrt{f'_c} b_w d_v \quad (11.5.4.1)$$

$$0.25 d \leq 12 \text{ inches} \quad \text{for } V_s > 4 \sqrt{f'_c} b_w d_v \quad (11.5.4.3)$$

- Torsion reinforcement

- Torsion reinforcement should be provided if

$$\tau_c > \lambda \sqrt{f'_c} \sqrt{1 + \frac{N_u}{4A_g \sqrt{f'_c}}} \quad (11.6.1)$$

- $$\frac{A_t}{s} = \frac{T_n}{2A_o f_{yv}}$$
 (11.6.3.5)

- $$A_l = \frac{A_t}{s} P_h \left(\frac{f_{yv}}{f_{yl}} \right)$$
 (11.6.3.7)

- Minimum $A_l = \frac{5\lambda \sqrt{f'_c} A_{cp}}{f_{yl}} - \frac{A_t}{s} P_h \frac{f_{yv}}{f_{yl}}$ for $\frac{A_t}{s} \geq \frac{25b_w}{f_{yv}}$ (11.6.5.3)

- Maximum spacing of stirrups

$$\frac{P_h}{8} \leq 12.0 \text{ inches} \quad (11.6.6.1)$$

- Minimum shear reinforcement

$$\text{Minimum } \left(\frac{A_v}{s} + 2 \frac{A_t}{s} \right) = .75 \lambda \sqrt{f'_c} \frac{b_w}{f_{yv}} \geq 50 \frac{b_w}{f_{yv}} \quad (11.6.5.2)$$

TOTAL SHEAR STRESS

$$v_f = \sqrt{v_u^2 + \left(\frac{\tau_u}{1.7} \right)^2} \quad \text{for solid section} \quad (11.6.3.1)$$

- Maximum shear stress

$$v_f \leq v_c + 8 \sqrt{f'_c} \quad (11.6.3.1)$$

B. CSA23.3-94 (simplified method)

- Definitions:

d = Distance from extreme compression fiber to centroid of longitudinal tension reinforcement. For circular section, distance from extreme compression fiber to centroid of longitudinal reinforcement in the opposite half.

b_w = Web width or (0.8 diameter) of circular section.

$$V_s = V_f - V_c \geq 0$$

$$v_c = \frac{V_c}{b_w d}$$

$$v_u = \frac{V_f}{b_w d}$$

$$\tau_c = \left(\frac{T_f P_{cp}}{A_{cp}^2} \right)$$

$$\tau_u = \left(\frac{T_f P_h}{A_{oh}^2} \right)$$

- $\phi_c = 0.6$ (8.4.2)
- $\phi_s = 0.9$ (8.4.3)
- Maximum usable $f_{yv} = 500$ MPa (8.5.1)
- Lightweight concrete (8.6.5)
 - $\lambda = 1.0$ for $W_c \geq 2400$ kg/m³
 - $\lambda = 0.85$ for $W_c = 2000$ kg/m³
 - $\lambda = 0.75$ for $W_c \leq 1600$ kg/m³

Linear relationship between W_c and λ is assumed between the abovementioned values.

- **SHEAR STRENGTH PROVIDED BY CONCRETE:**

$$V_c = 0.2 \left(1 - \frac{N_f}{0.6\lambda\phi_c\sqrt{f'_c}A_g} \right) \lambda \phi_c \sqrt{f'_c} b_w d \quad N_f \geq 0 \quad (\text{CSA23.3-84/11.3.4.2})$$

$$V_c = 0.2 \lambda \sqrt{f'_c} b_w d \quad N_f \leq 0 \quad (11.3.5.1)$$

- Shear reinforcement
 - Shear reinforcement should be provided if $v_u > 0.5 v_c$ (11.2.8.1)
 - $\frac{A_v}{s} = \frac{\phi_s V_s}{f_{yv} d}$ (11.3.7)
- Maximum spacing of stirrups (11.2.11)

$$0.7 d \leq 600 \text{ mm}$$

$$\text{for } Vu < 0.1 \lambda \phi_c f'_c$$

$$0.35 d \leq 300 \text{ inches}$$

$$\text{for } Vu \geq 0.1 \lambda \phi_c f'_c$$

- Torsion reinforcement

- Torsion reinforcement should be provide if $\tau_c > \lambda 0.1 \phi_c \sqrt{f'_c}$ (11.2.9.1)

- $\frac{A_t}{s} = \frac{T_f}{2A_o \phi_s f_{yv}}$ (11.3.9.4)

- $A_l = \frac{A_t}{s} P_h \left(\frac{f_{yv}}{f_{yl}} \right)$ (11.3.9.5)

- Maximum spacing of stirrups

$$\frac{P_h}{8} \leq 300 \text{ mm} \quad (\text{CSA23.3-84/11.3.8.4})$$

- **MINIMUM SHEAR REINFORCEMENT**

$$\text{Minimum } \left(\frac{A_v}{s} + 2 \frac{A_t}{s} \right) = 0.06 \sqrt{f'_c} \frac{b_w}{f_{yv}} \quad (11.2.8.4)$$

- Total shear stress

$$v_f = v_u + \tau_u \quad (11.3.9.8)$$

- Maximum shear stress

$$v_f \leq 0.25 \phi_c f'_c \quad (11.3.9.8)$$

$$v_u \leq v_c + 0.8 \lambda \phi_c \sqrt{f'_c} \quad (11.3.4)$$

Conversion Factors - English to SI

To convert from	To	Multiply by
in.	m (1000 mm)	0.025400
ft	m	0.304800
lb	N (0.001 kN)	4.448222
kip (1000 lbs)	kN	4.448222
plf (lb/ft)	N/m	14.593904
psi (lb/in. ²)	kPa	6.894757
ksi (kips/in. ²)	MPa	6.894757
psf (lb/ft ²)	N/m ² (Pa)	47.88026
pcf (lb/ft ³)	kg/m ³	16.018460
ft-kips	kN • m	1.355818

Conversion Factors - SI to English.

To convert from	To	Multiply by
m (1000 mm)	in	39.37008
m	ft	3.28084
N (0.001 kN)	lb	0.224809
kN	kip (1000 lbs)	0.224809
kN/m	plf (lb/ft)	68.52601
MPa	psi (lb/in. ²)	145.0377
MPa	ksi (kips/in. ²)	0.145038
kN/m ² (kPa)	psf (lb/ft ²)	20.88555
kg/m ³	pcf (lb/ft ³)	0.062428
kN • m	ft-kips	0.737562

Contact Information

Web Site: <http://www.pcaStructurePoint.com>

E-mail: info@pcaStructurePoint.com
support@pcaStructurePoint.com

Ordering: pcaStructurePoint
Attn: Customer Service
5420 Old Orchard Road
Skokie, IL 60077
USA

Phone: (847) 972-9042
Fax: (847) 972-9043

Technical Support: pcaStructurePoint
5420 Old Orchard Road
Skokie, IL 60077
USA

Phone: (847) 966-HELP / (847) 966-4357
Fax: (847) 581-0644

Bug Report Form

To help us improve our products please fax, mail or e-mail questions to:

pcaStructurePoint
 5420 Old Orchard Road
 Skokie, IL 60077
 Fax: (847) 581-0644
 E-mail: support@pcaStructurePoint.com

Program Name		Company Name	
Program Version		Tester's Name	
Program Release		Phone	
Operating System		Fax	
CPU / Memory		E-mail	
Network		Input File	
Bug No.		Output File	
Date		Screen Shot File	
Bug Priority Category			

<p>Problem Title <i>Please enter a brief, one-line description of the problem.</i></p>
<p>Summary Information <i>Restate the problem title and/or include more descriptive summary information.</i></p>
<p>Error Messages <i>If the problem causes any error messages, please list the exact error messages that you are receiving.</i></p>
<p>Steps to Reproduce <i>If the problem is reproducible, please list the steps required to cause it. If the problem is not reproducible (only happened once, or occasionally for no apparent reason), please describe the circumstances in which it occurred and the symptoms observed.</i></p>
<p>Results <i>Describe your results and how they differed from what you expected.</i></p>
<p>Workaround <i>If there is a workaround for the problem, please describe it in detail.</i></p>
<p>Documentation & Notes <i>Document any additional information that might be useful in resolving the problem.</i></p>

